

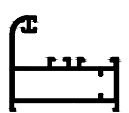

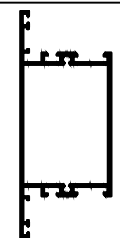





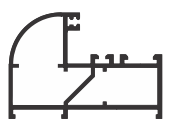
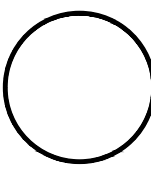
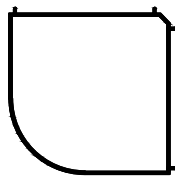
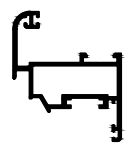
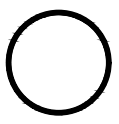
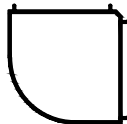
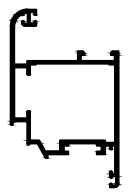

ALH62

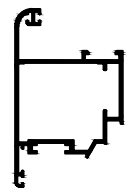

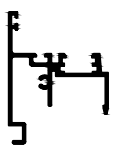
Oznaka Code	Izgled Design 1:4	Opis Description	Oznaka Code	Izgled Design 1:4	Opis Description	Oznaka Code	Izgled Design 1:4	Opis Description
6211 $\frac{G}{Kg/m'}$ 0.990		Štok Frame	6235 $\frac{G}{Kg/m'}$ 1.550		"T" profil "T" profile	6253 $\frac{G}{Kg/m'}$ 0.336		Nosač četkice Door brush rabbet seal
6213 $\frac{G}{Kg/m'}$ 1.230		Štok Frame	6204 $\frac{G}{Kg/m'}$ 0.666		Dopuna Rabbet	62 U1 $\frac{G}{Kg/m'}$ 1.227		Dopuna za < 90° Rabbet for < 90°
6221 $\frac{G}{Kg/m'}$ 1.090		Krilo Sash	6205 $\frac{G}{Kg/m'}$ 0.450		Dopuna Rabbet	62 U2 $\frac{G}{Kg/m'}$ 0.862		Dopuna za < 90° Rabbet for < 90°
6222 $\frac{G}{Kg/m'}$ 1.350		Krilo Sash	6202 $\frac{G}{Kg/m'}$ 0.507		Dopuna štoka Frame rabbet	OK 1 $\frac{G}{Kg/m'}$ 0.150	 (1:2)	Otkapnica Drip profile
6223 $\frac{G}{Kg/m'}$ 1.350		Krilo Sash	6203 $\frac{G}{Kg/m'}$ 0.373		Dopuna štoka Frame rabbet	877 $\frac{G}{Kg/m'}$ 0.130		Pogonska letva Operating rod
6241 $\frac{G}{Kg/m'}$ 0.973		Srednja dopuna Central rabbet	6201 $\frac{G}{Kg/m'}$ 0.369		Prag Threshold			
6231 $\frac{G}{Kg/m'}$ 1.150		"T" profil "T" profile	6251 $\frac{G}{Kg/m'}$ 0.360		Dopuna štoka Frame rabbet			

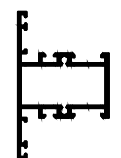
6211

Štok

Frame

0.990 Kg/m'

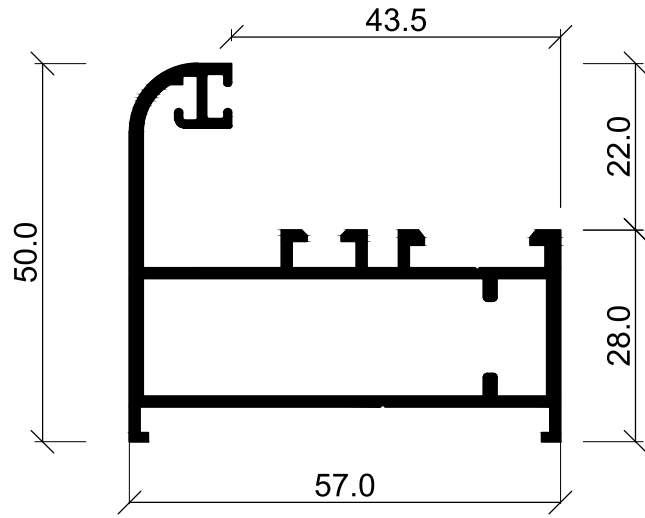
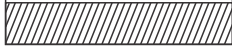

6213

Štok

Frame

1.230 Kg/m'

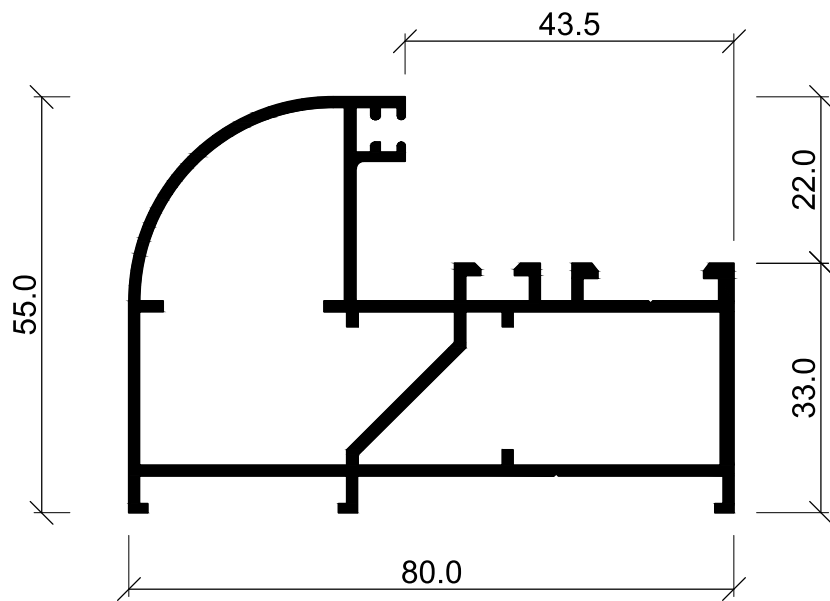
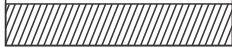

6221
 Krilo
 Sash
 1.090 Kg/m'

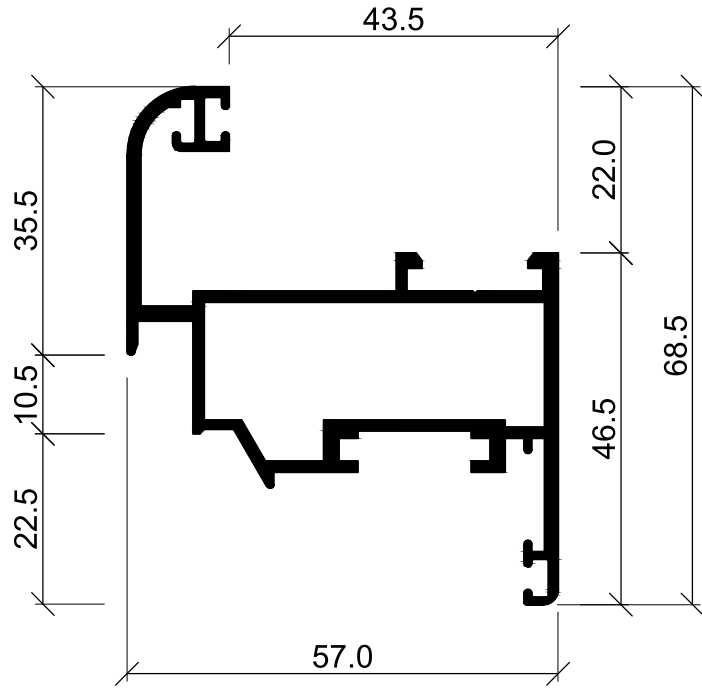

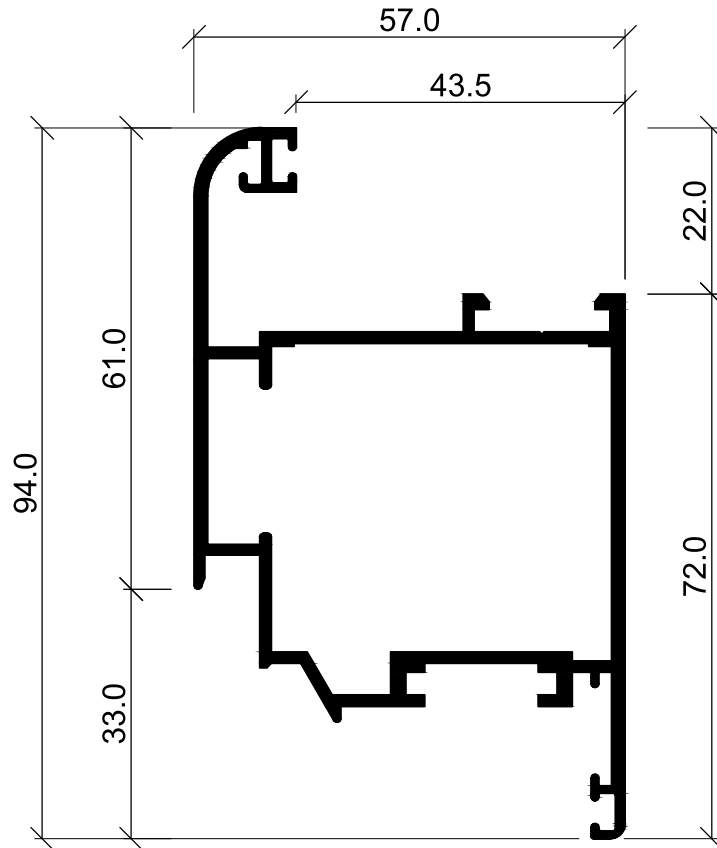

6222
 Krilo
 Sash
 1.350 Kg/m'

6223

Krilo
Sash
1.350 Kg/m'

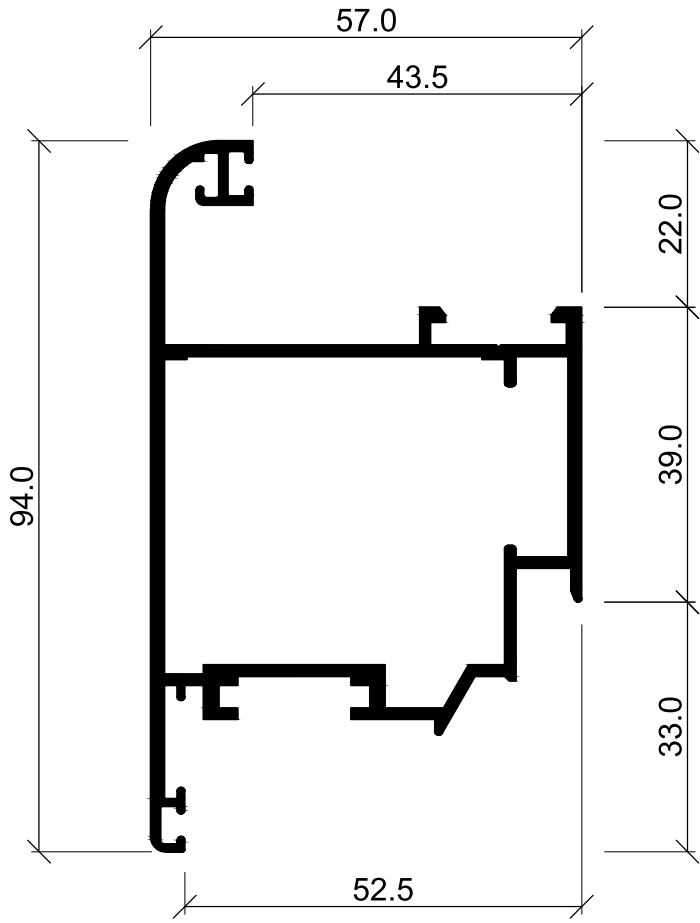
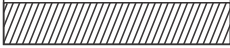

6231

"T" profil
"T" profile
1.150 Kg/m'

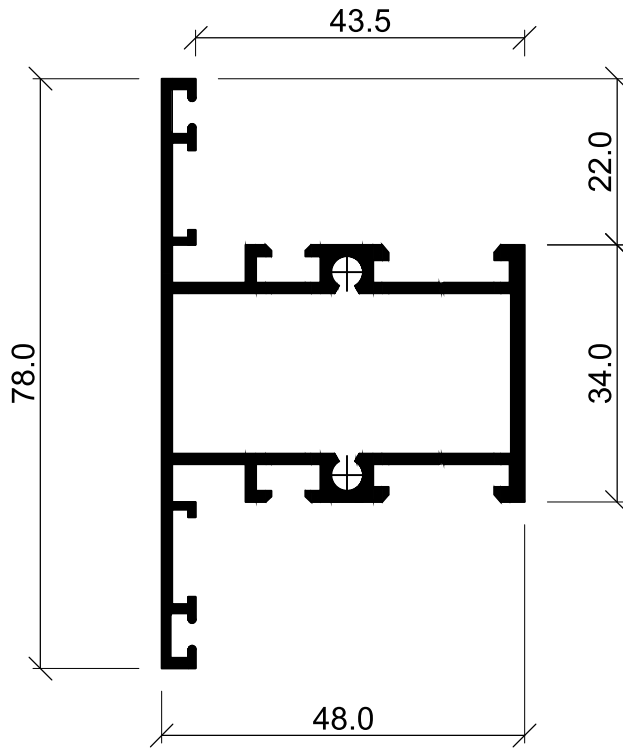
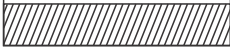

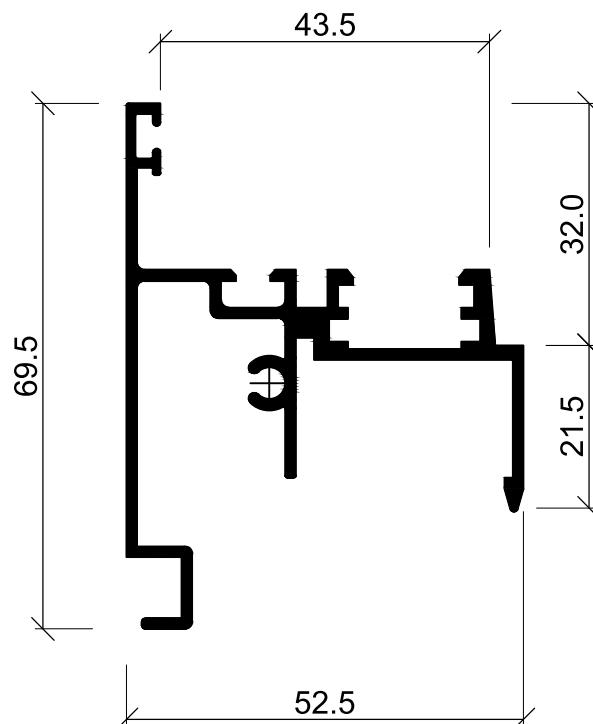
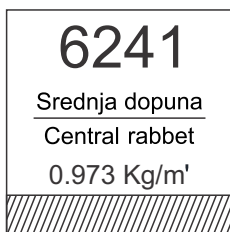
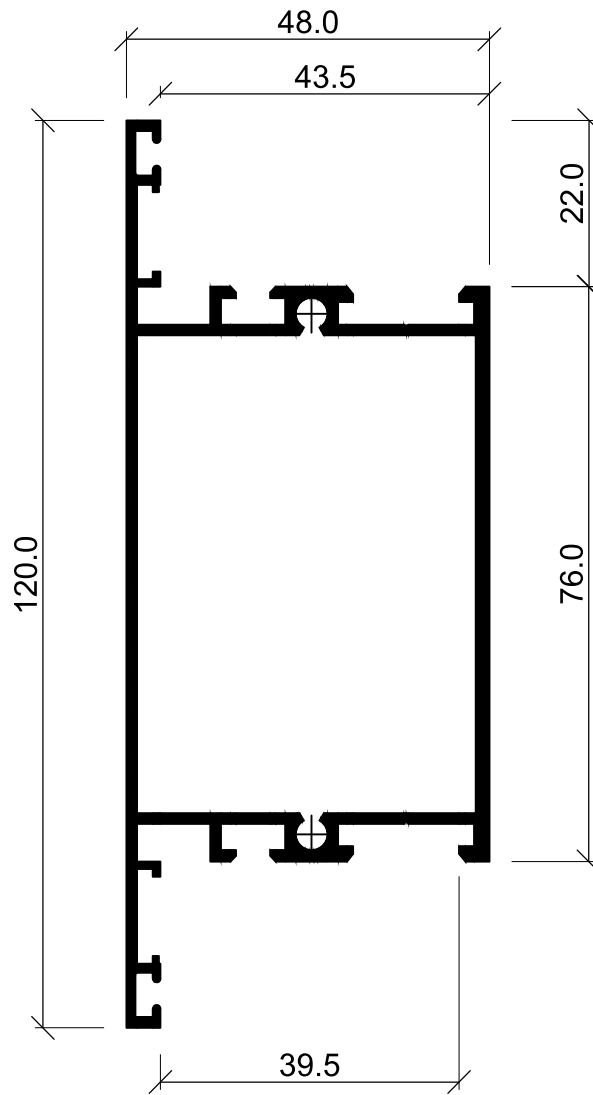
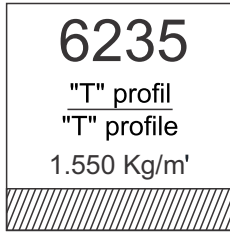

62U1

Dopuna za < 90°
Rabbet for < 90°
1.227 Kg/m'

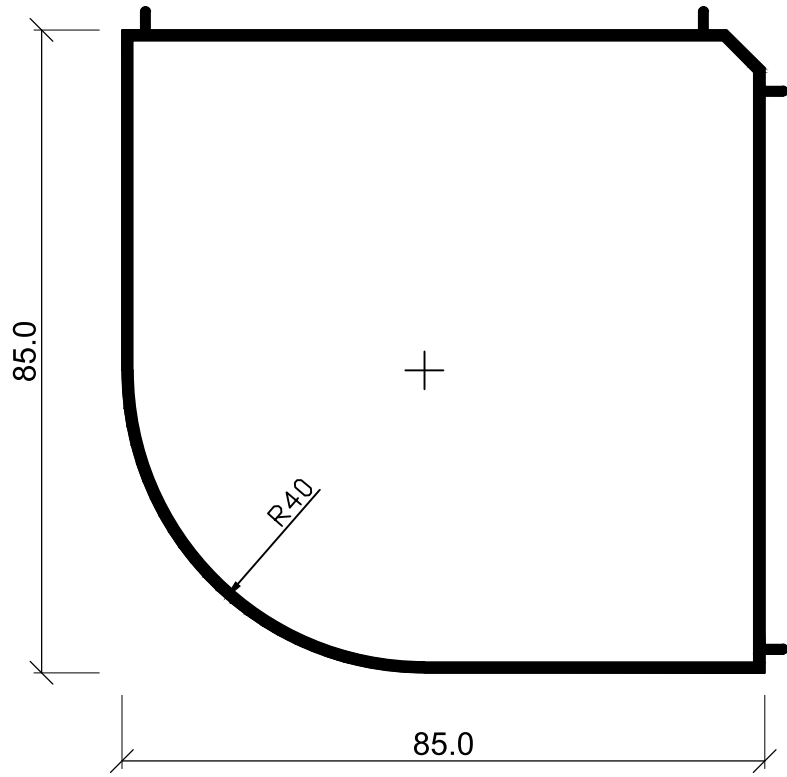
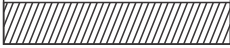

62U2

Dopuna za < 90°
Rabbet for < 90°
0.862 Kg/m'

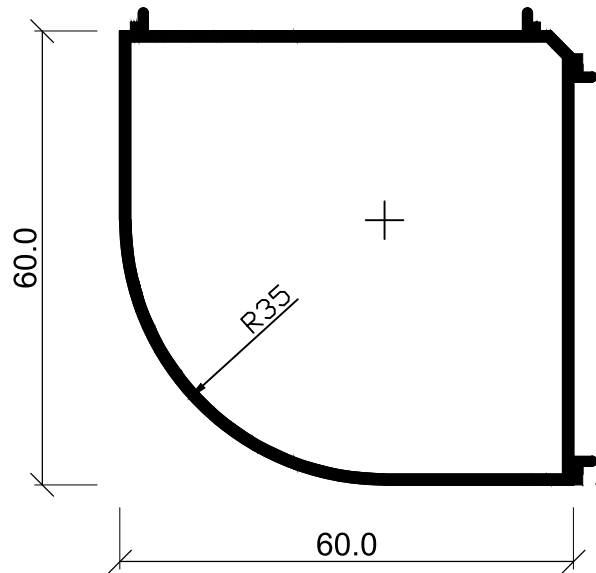
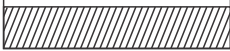

6204

Dopuna

Rabbet

0.666 Kg/m'

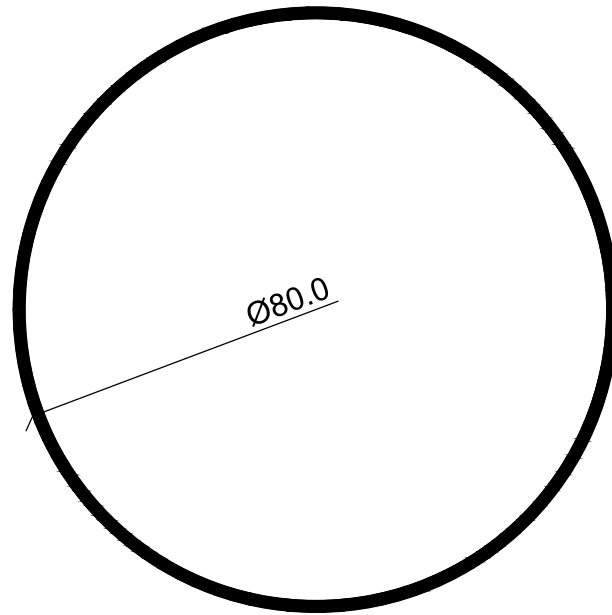
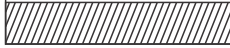
**6205**

Dopuna

Rabbet

0.450 Kg/m'

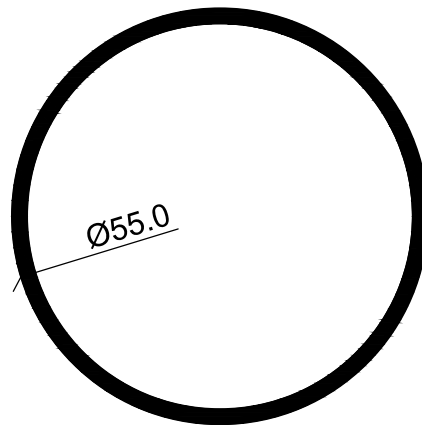
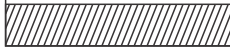
**6202**

Dopuna štoka

Frame rabbet

0.507 Kg/m'

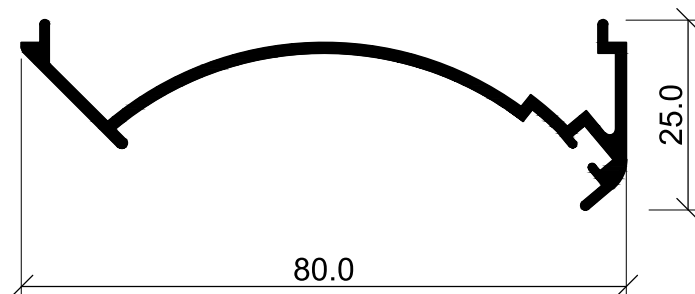
**6203**

Dopuna štoka

Frame rabbet

0.373 Kg/m'

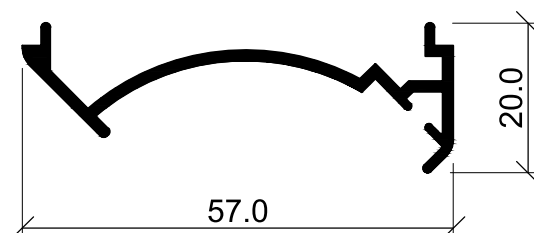

6251

Dopuna štoka

Frame rabbet

0.360 Kg/m'

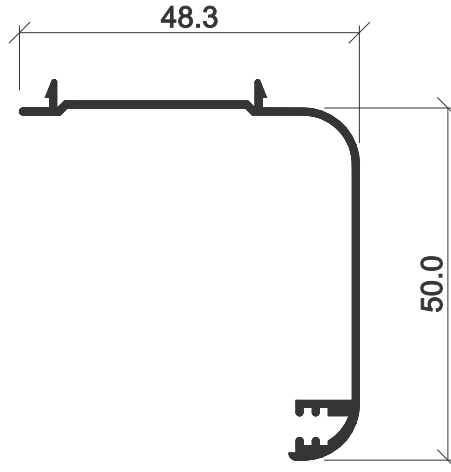
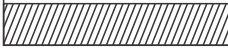

6253

Nosač četkice

Door brush
rabbet seal

0.336 Kg/m'

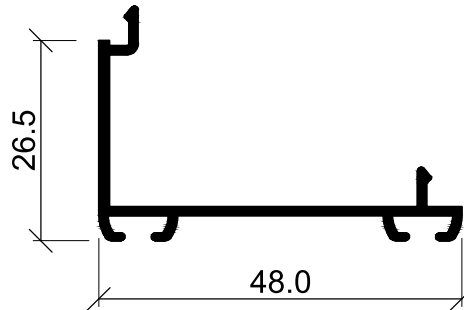
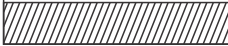

6201

Prag

Treshold

0.369 Kg/m'

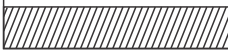

877

Pogonska letva

Operating rod

0.130 Kg/m'

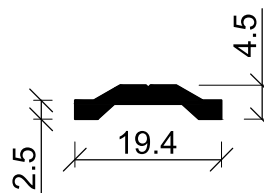

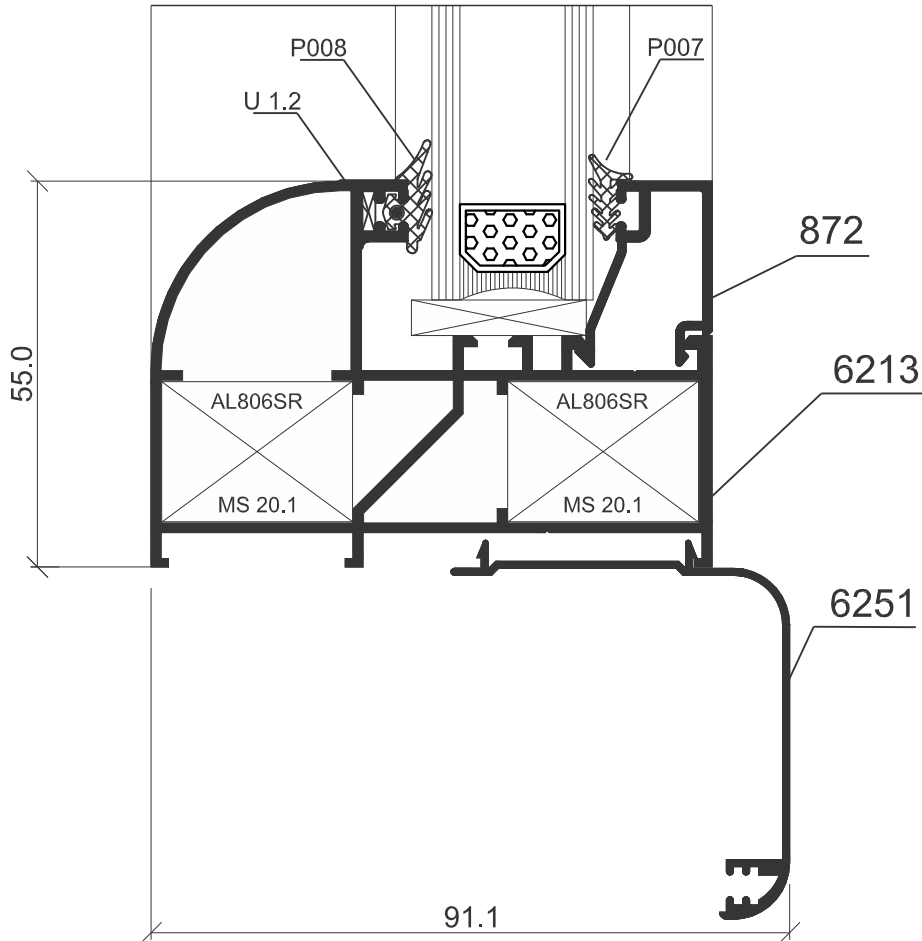
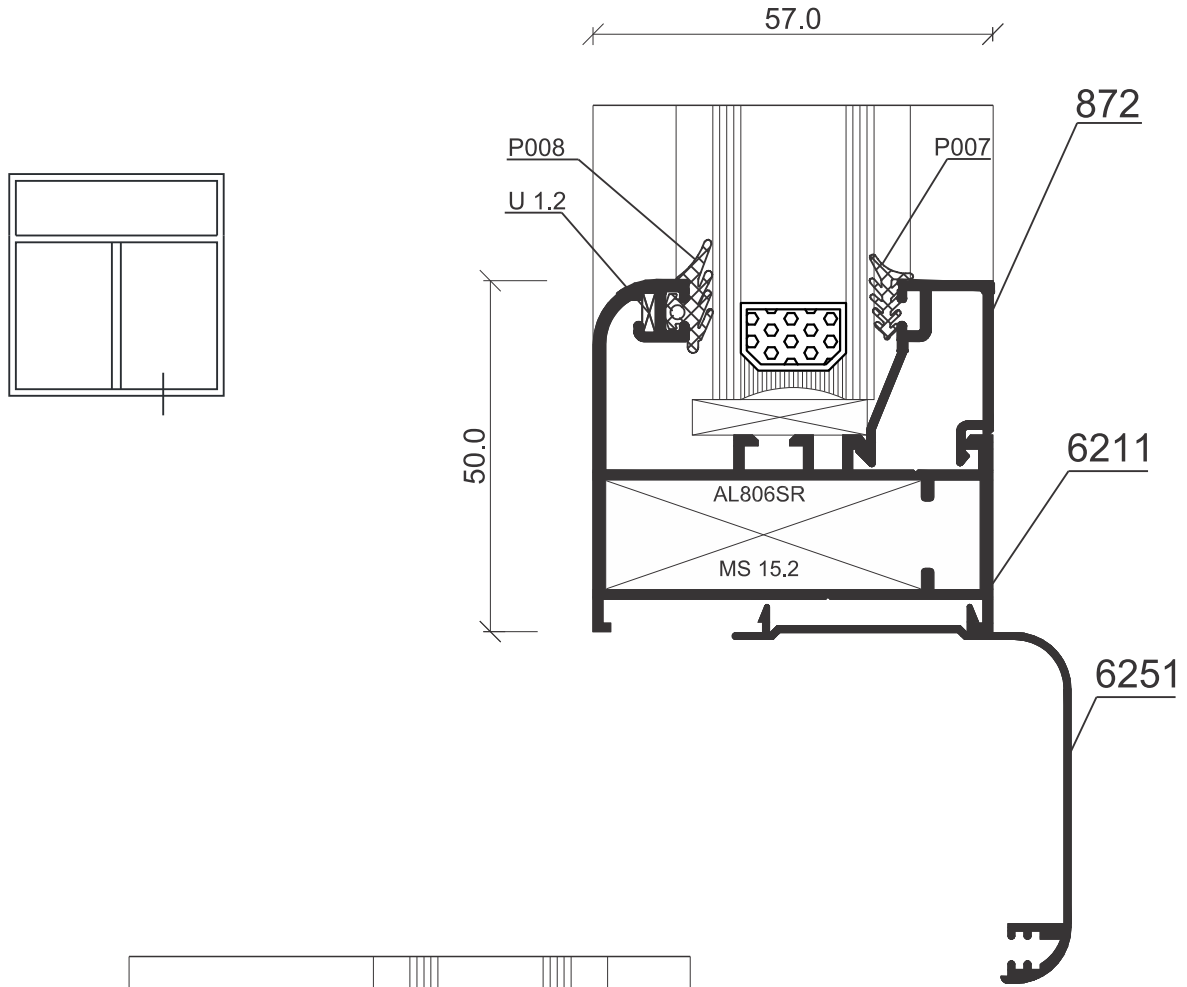

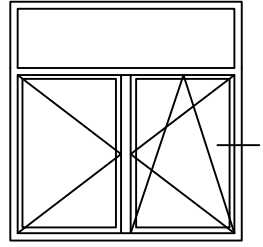
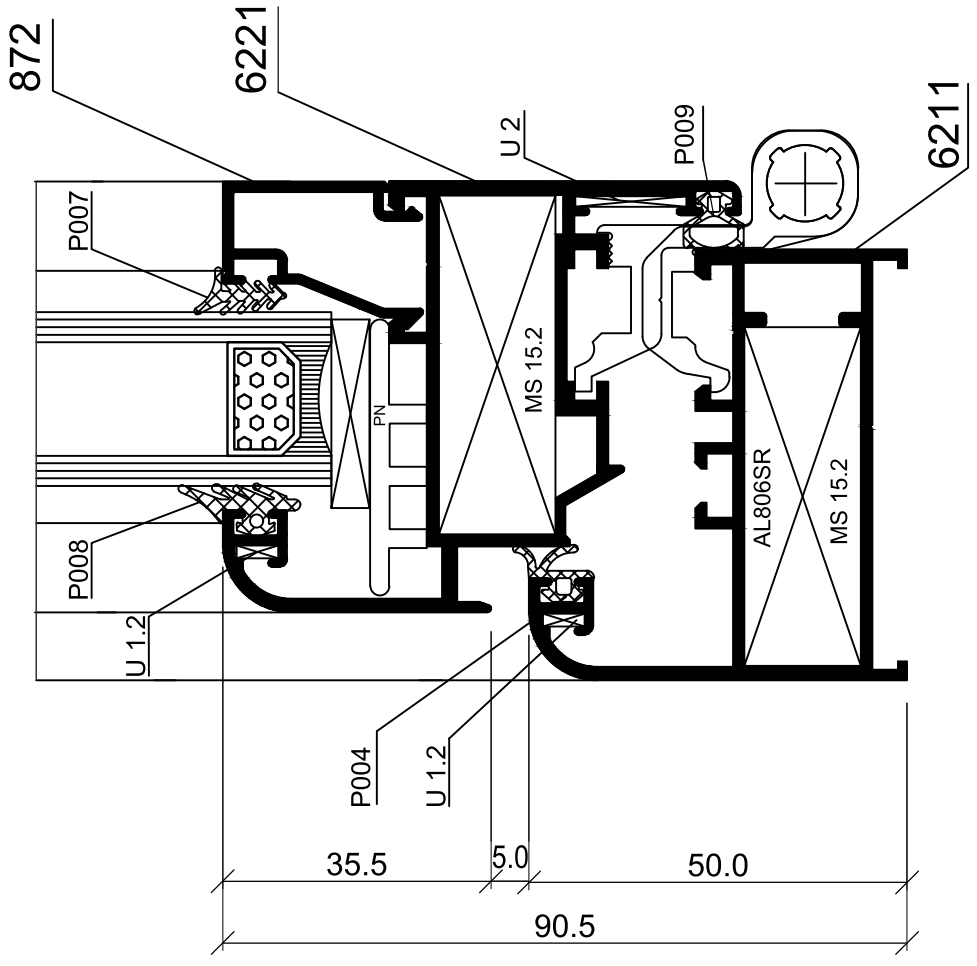

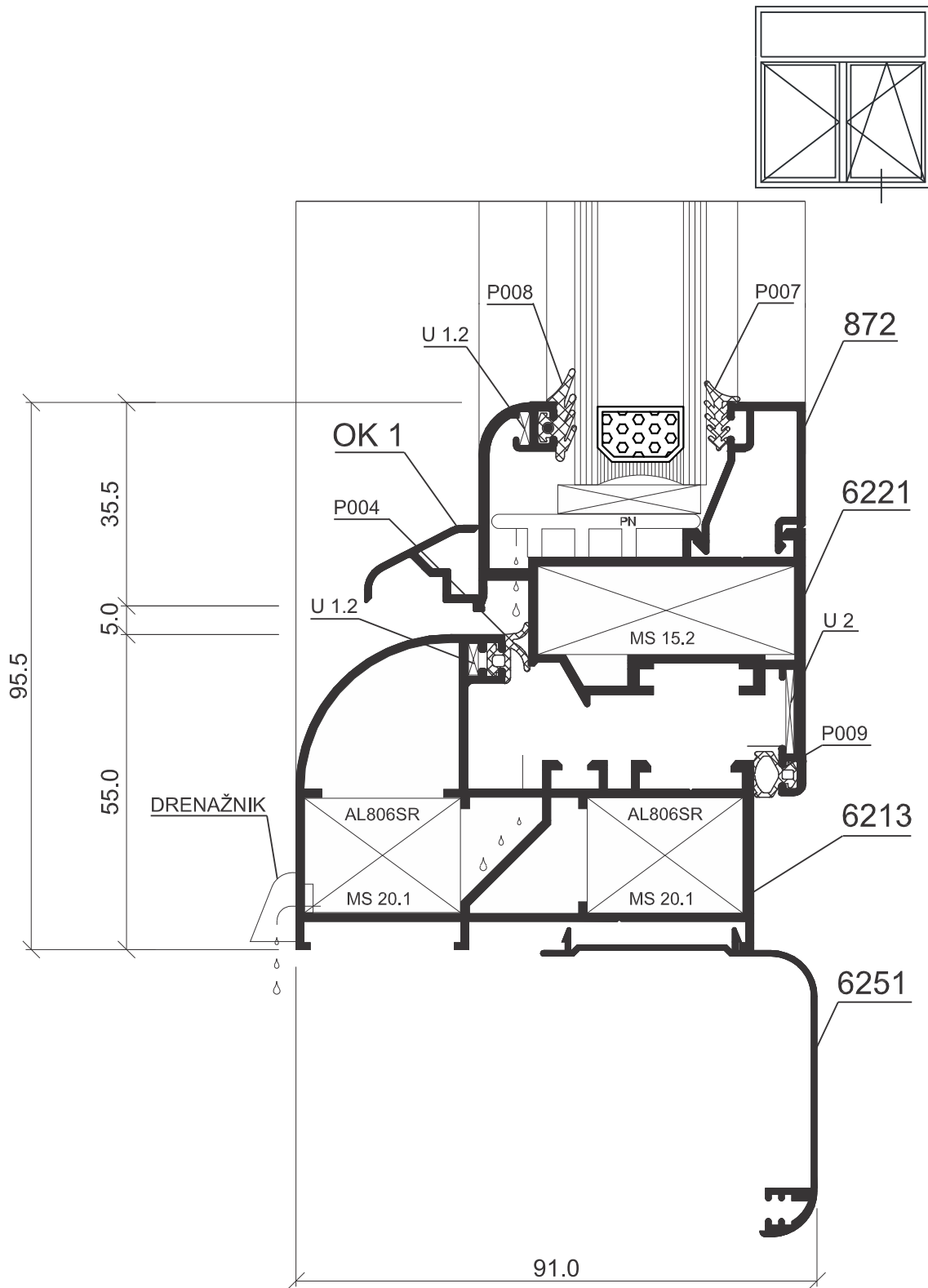

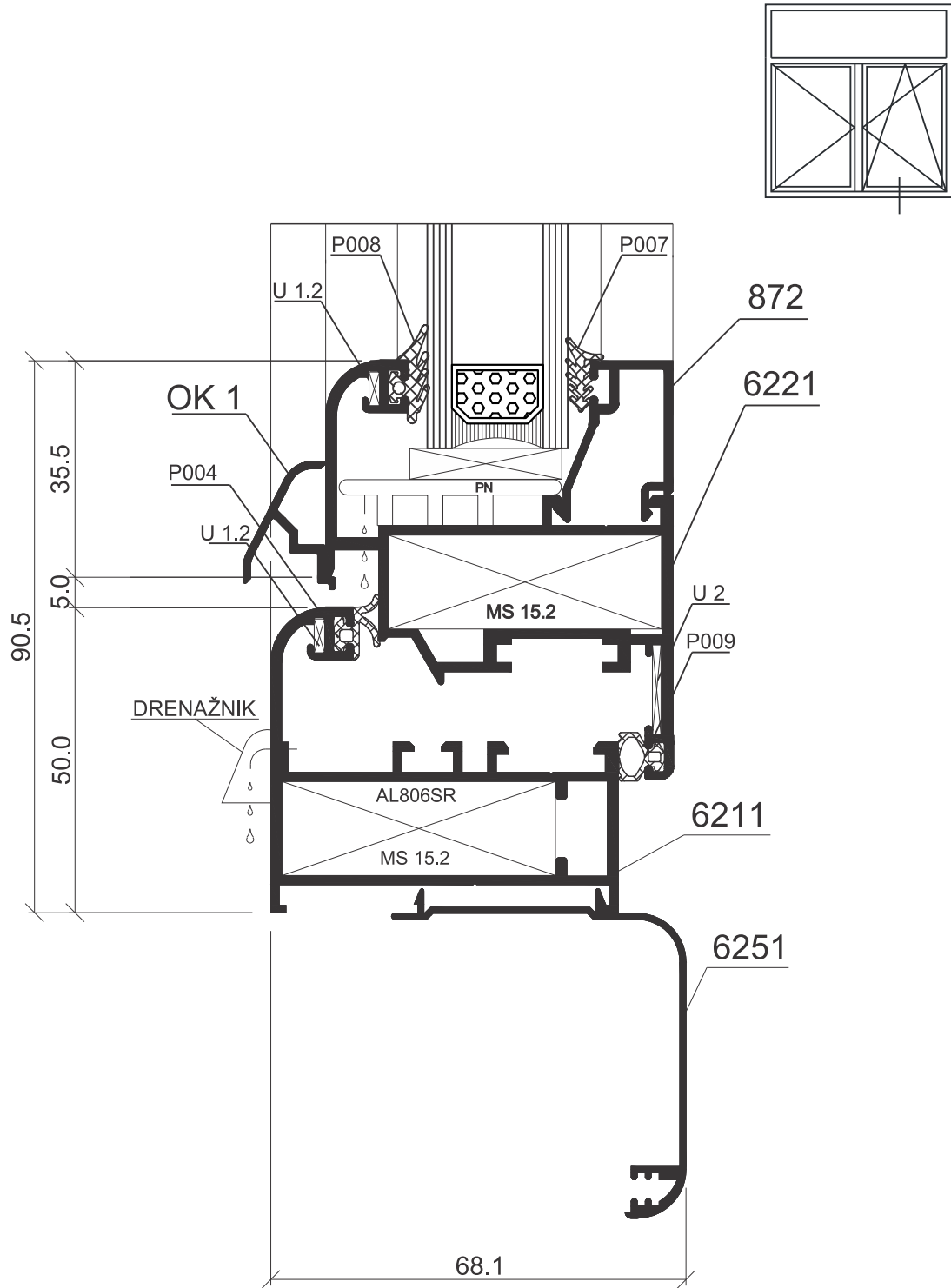

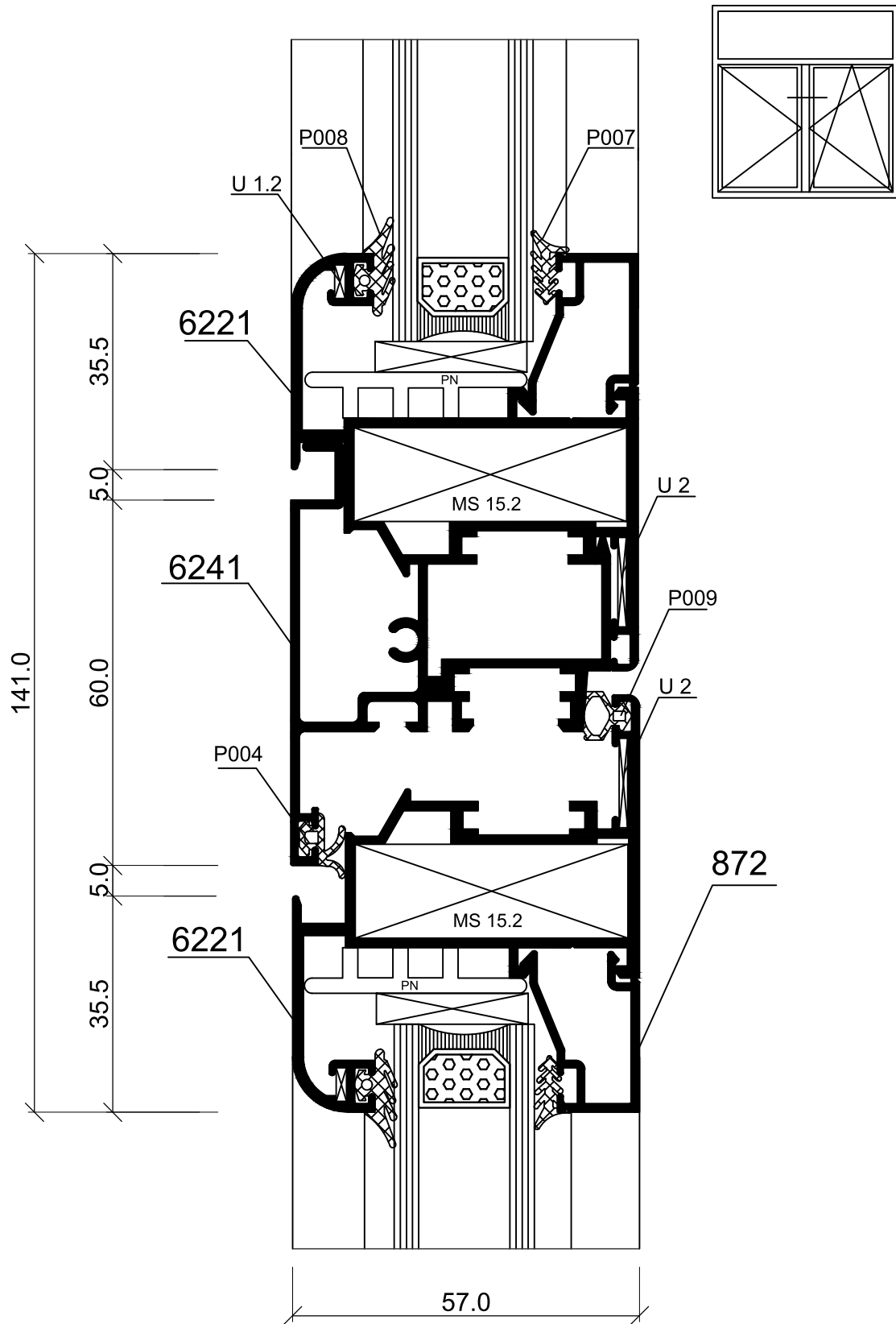

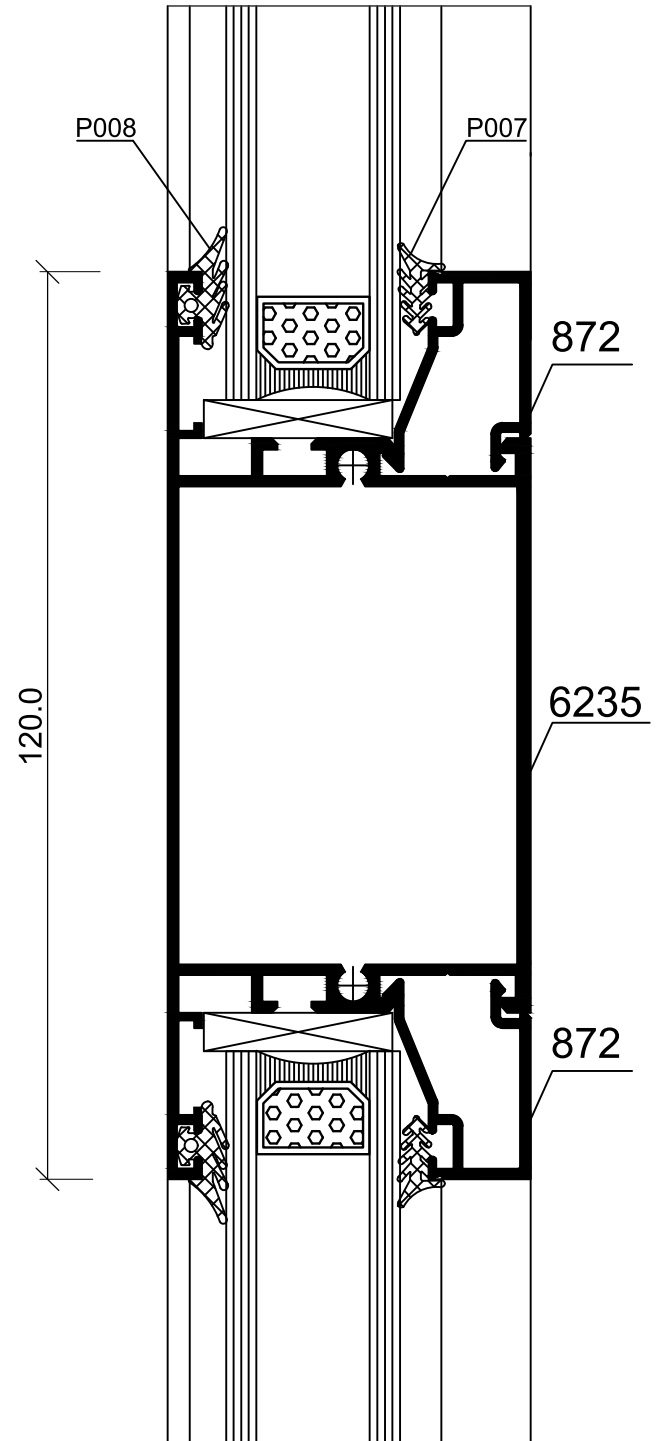
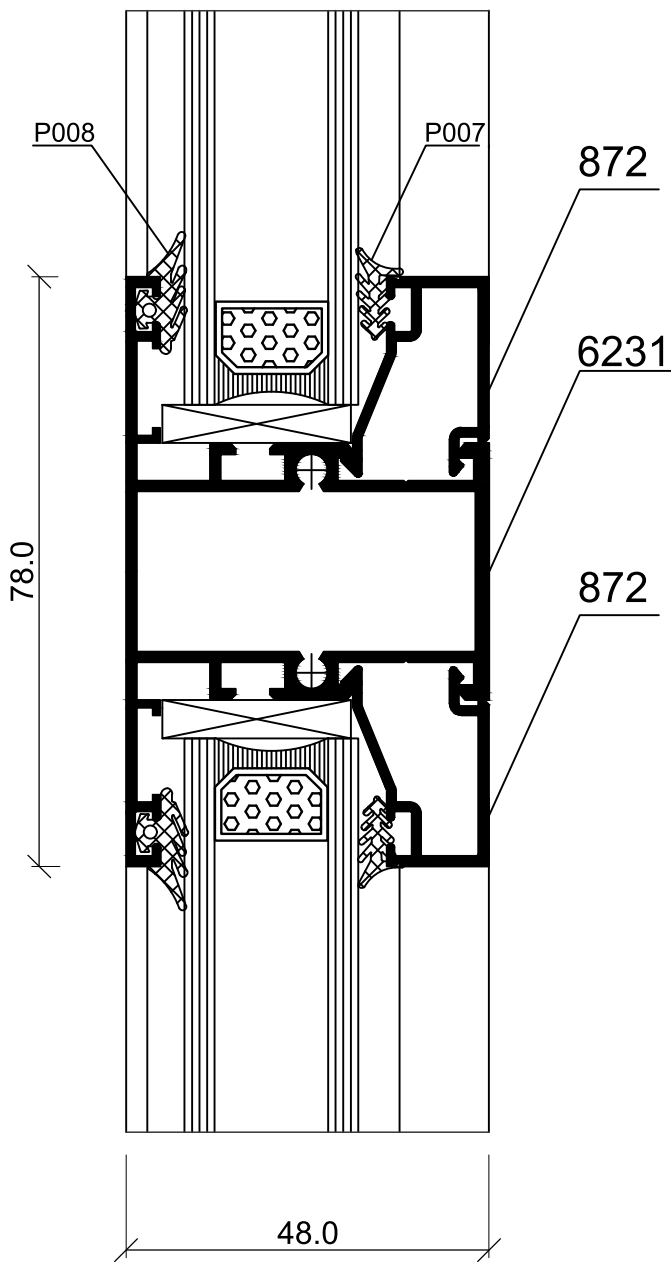
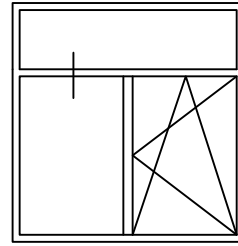

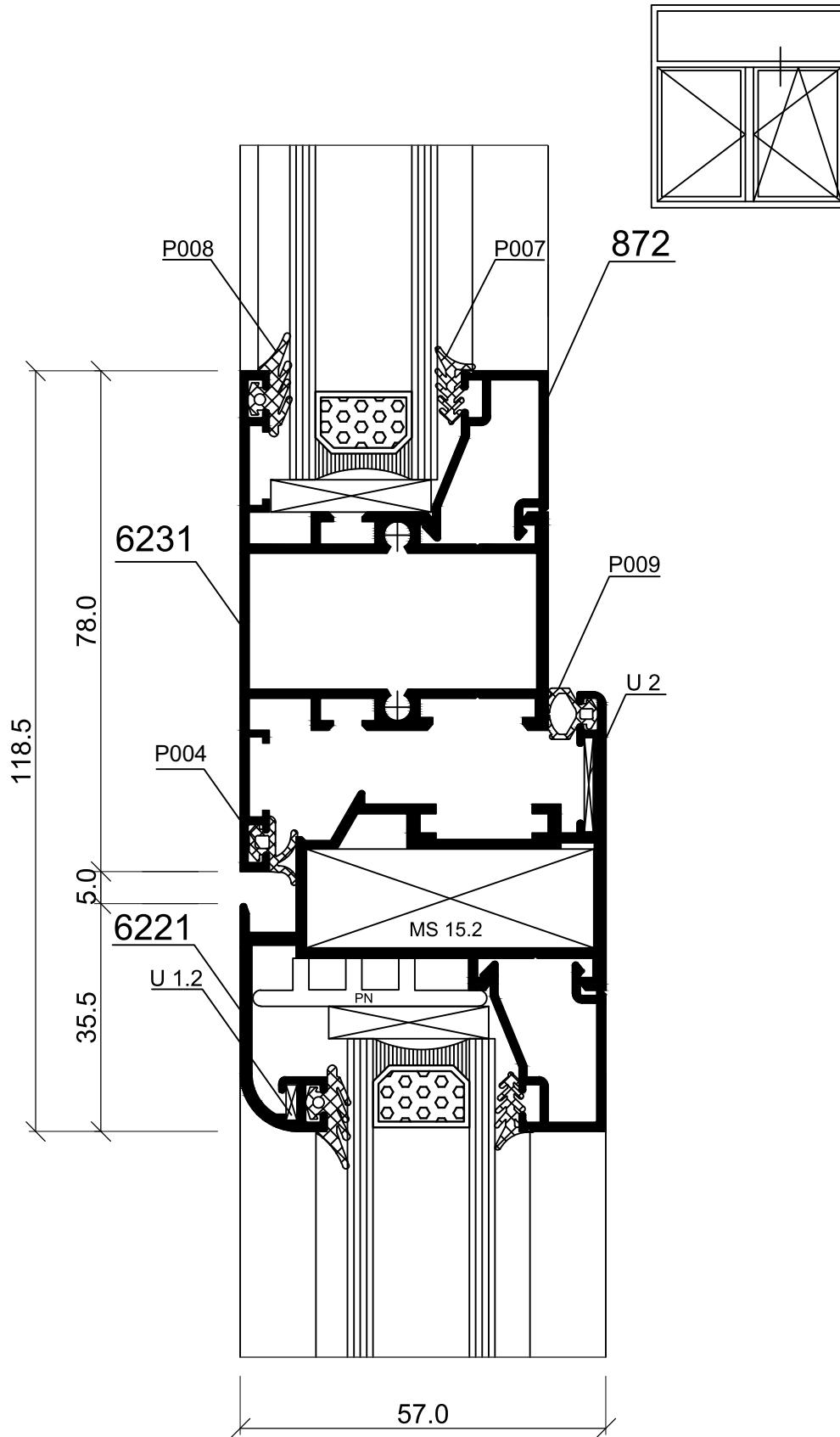

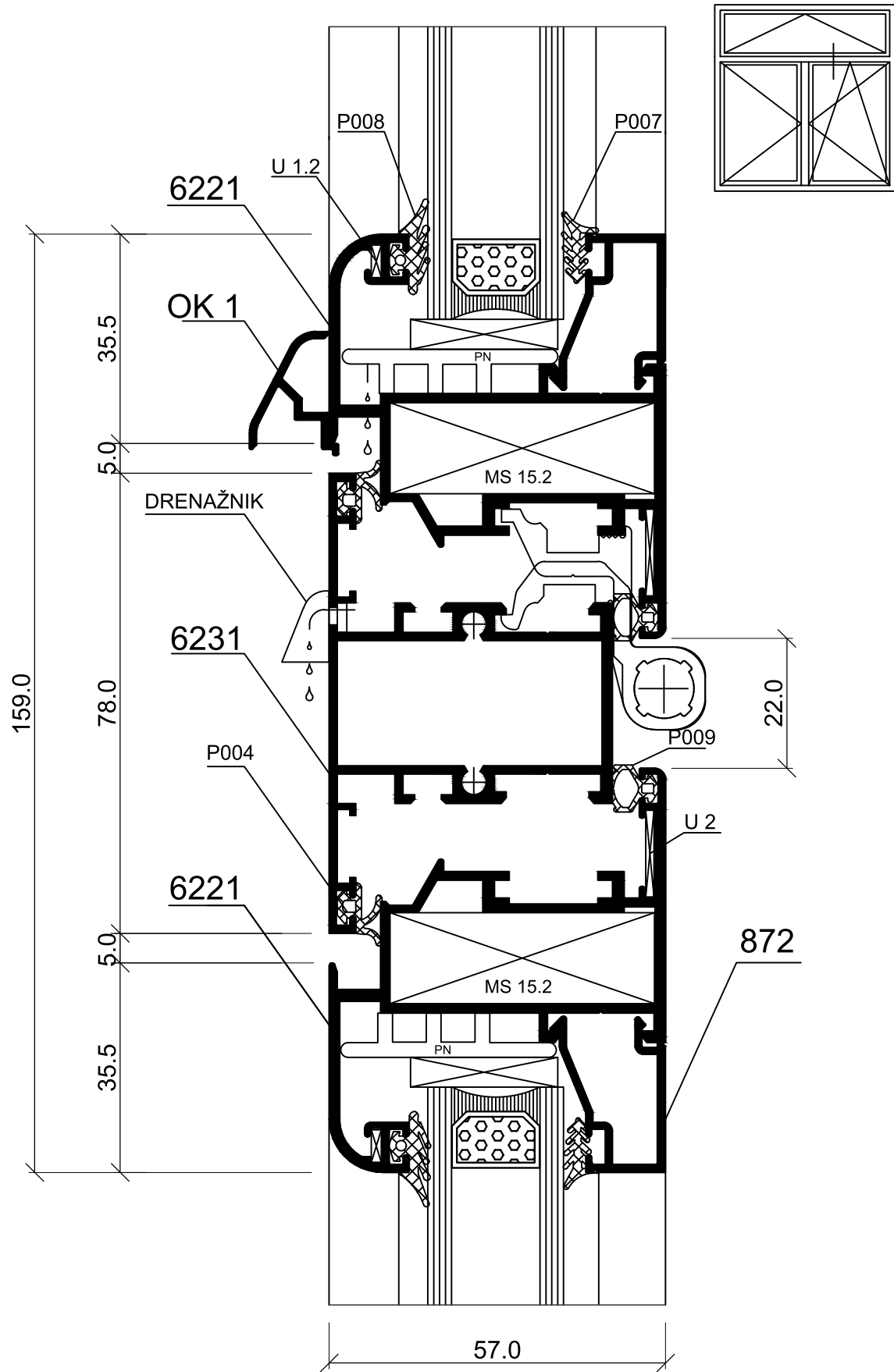

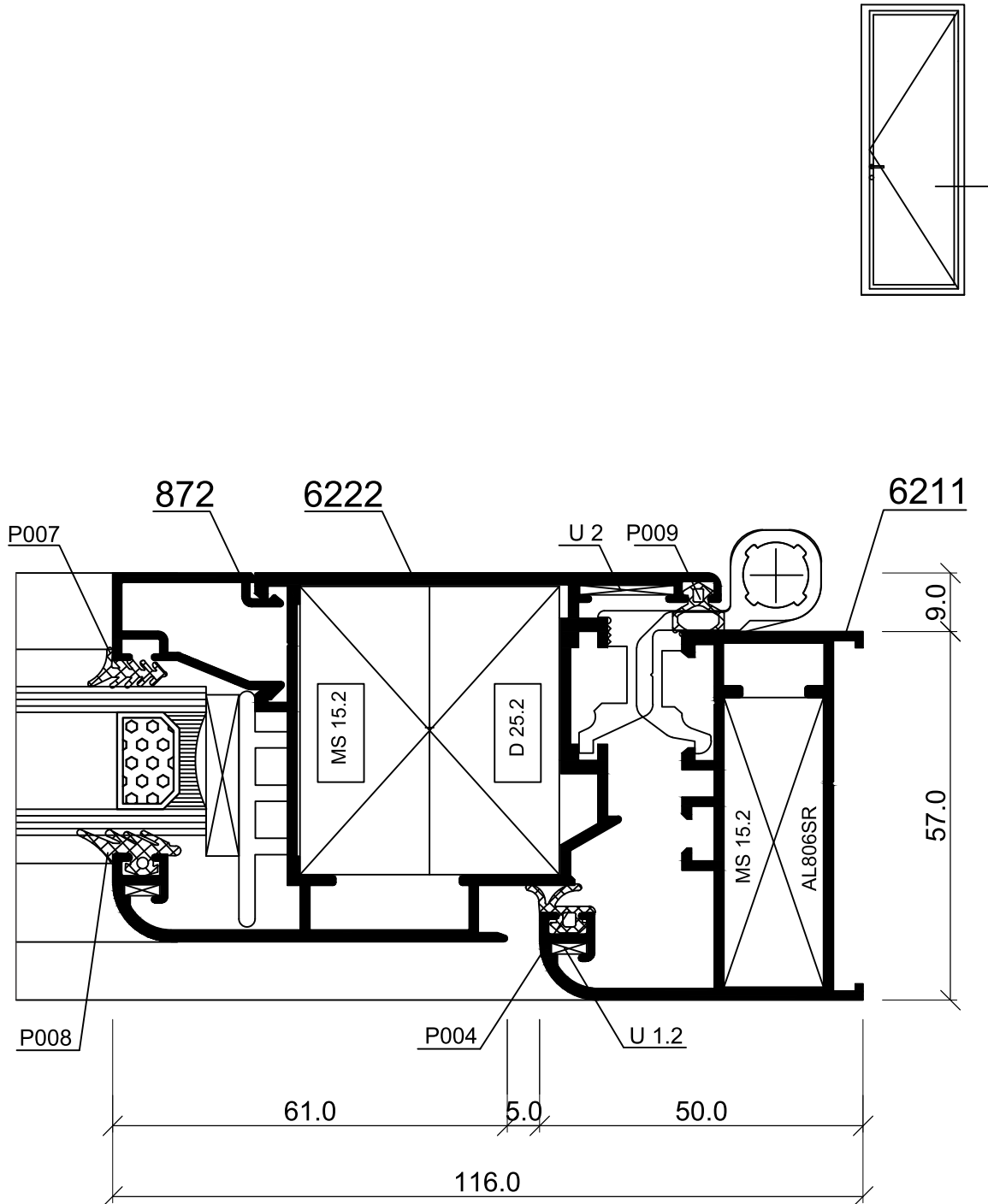

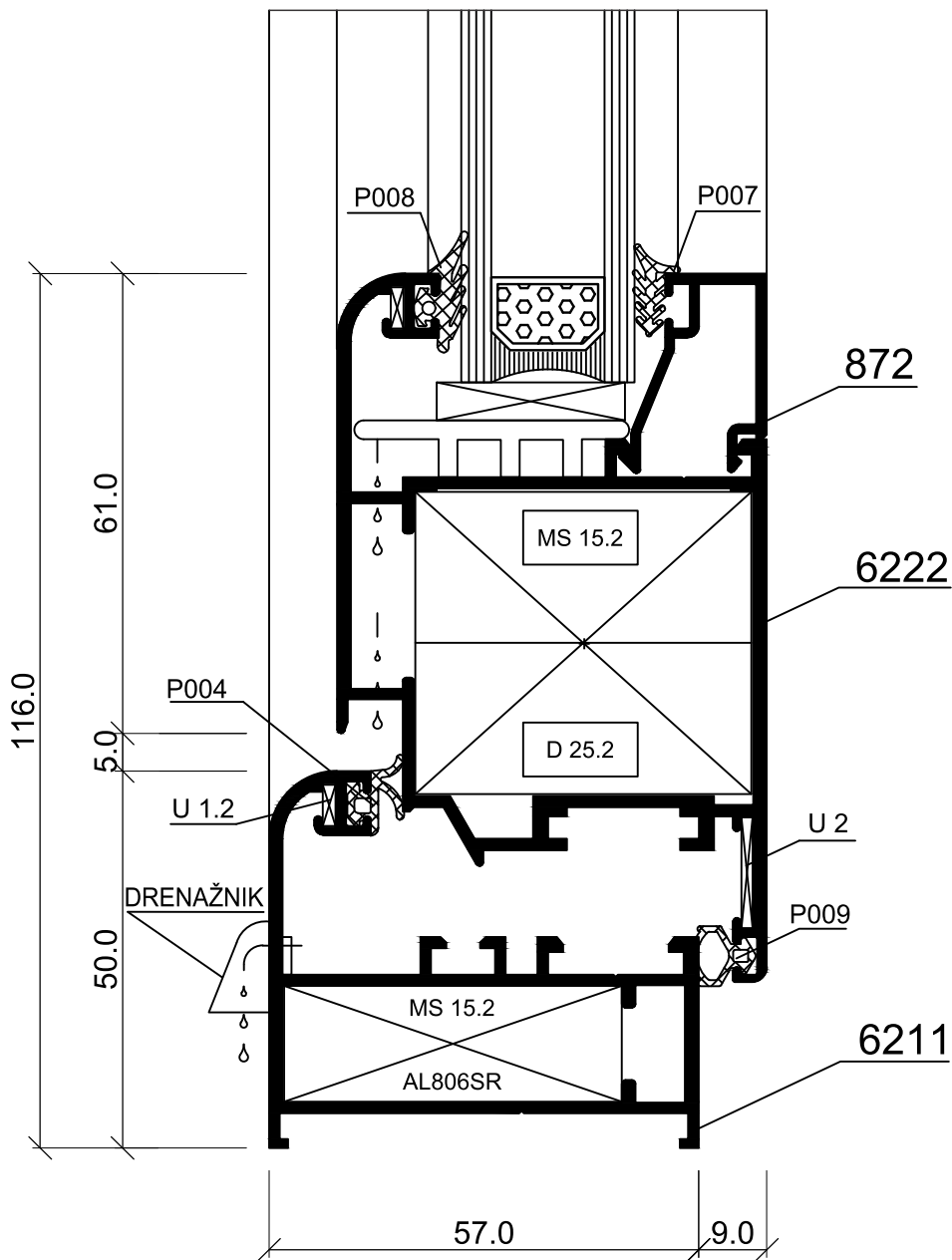
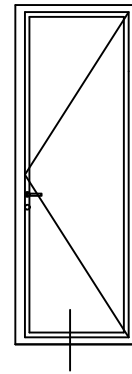

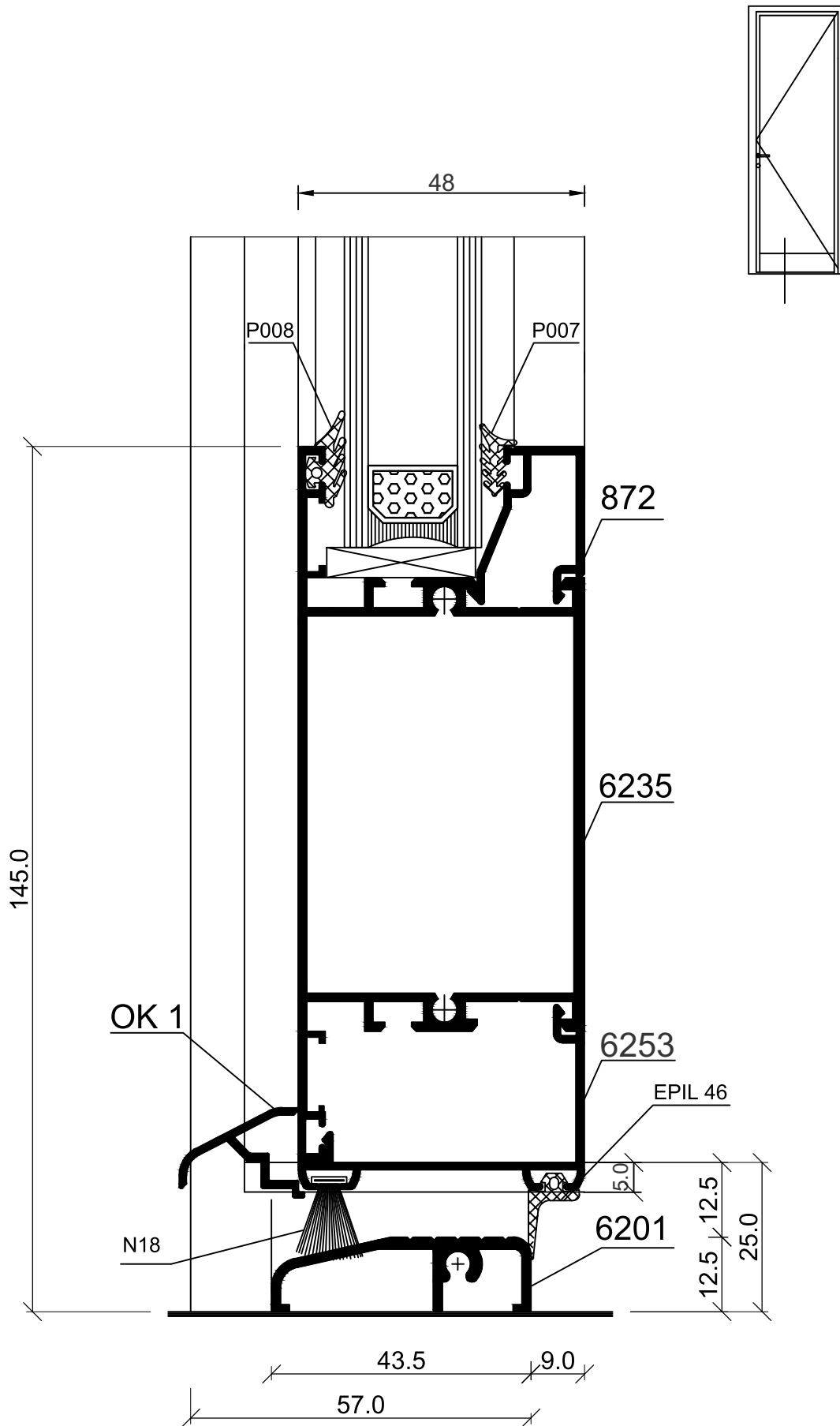

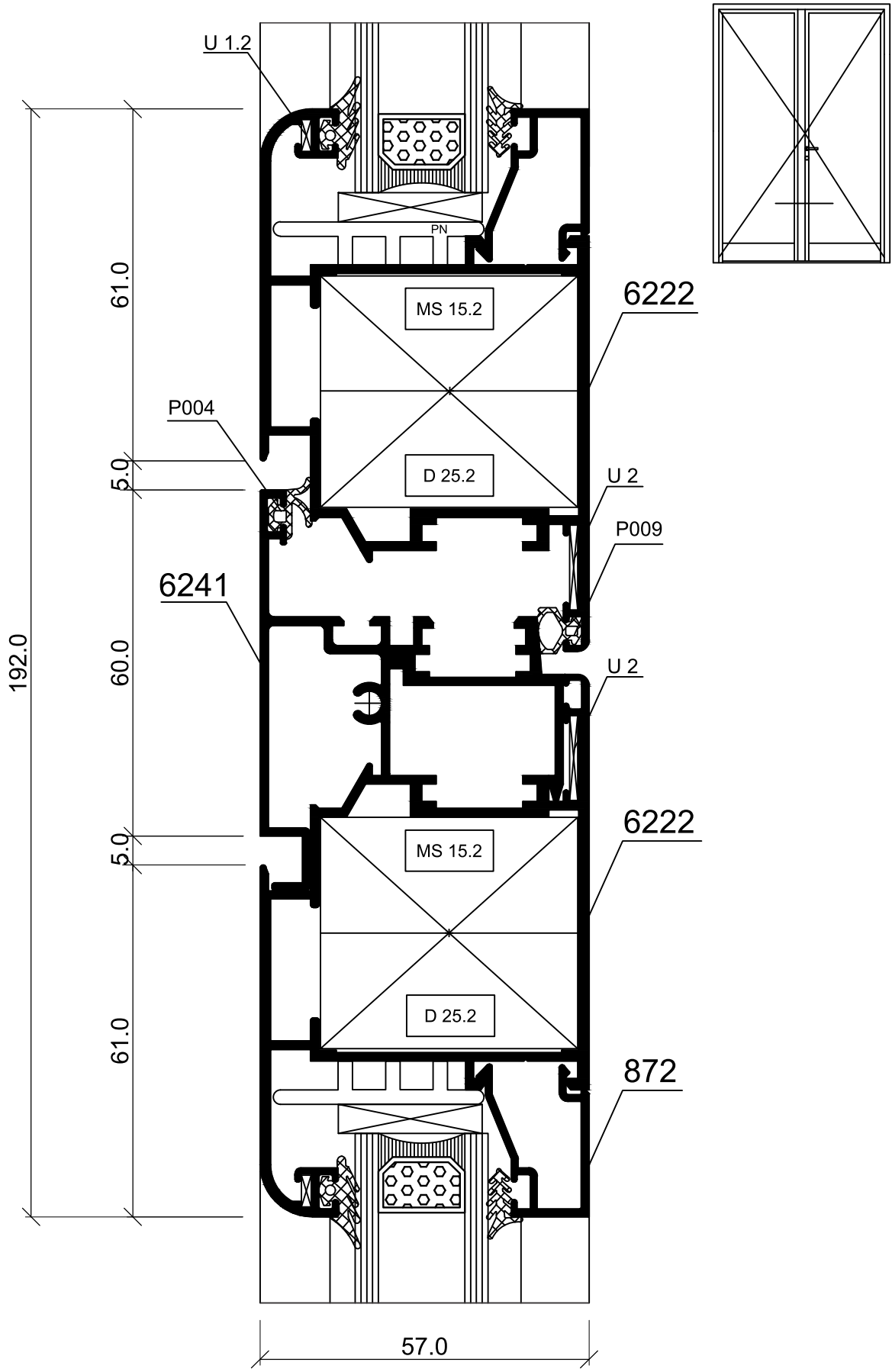

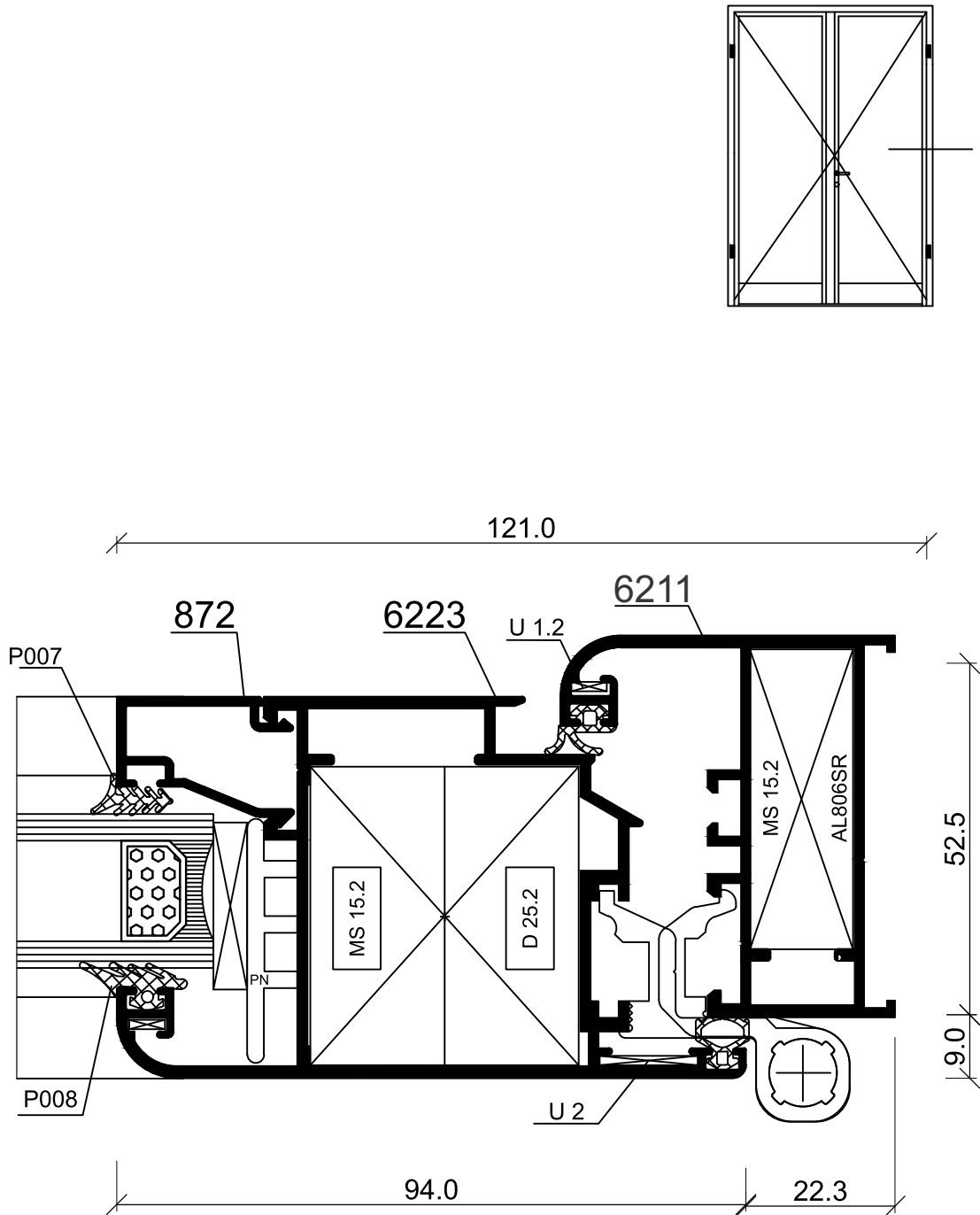

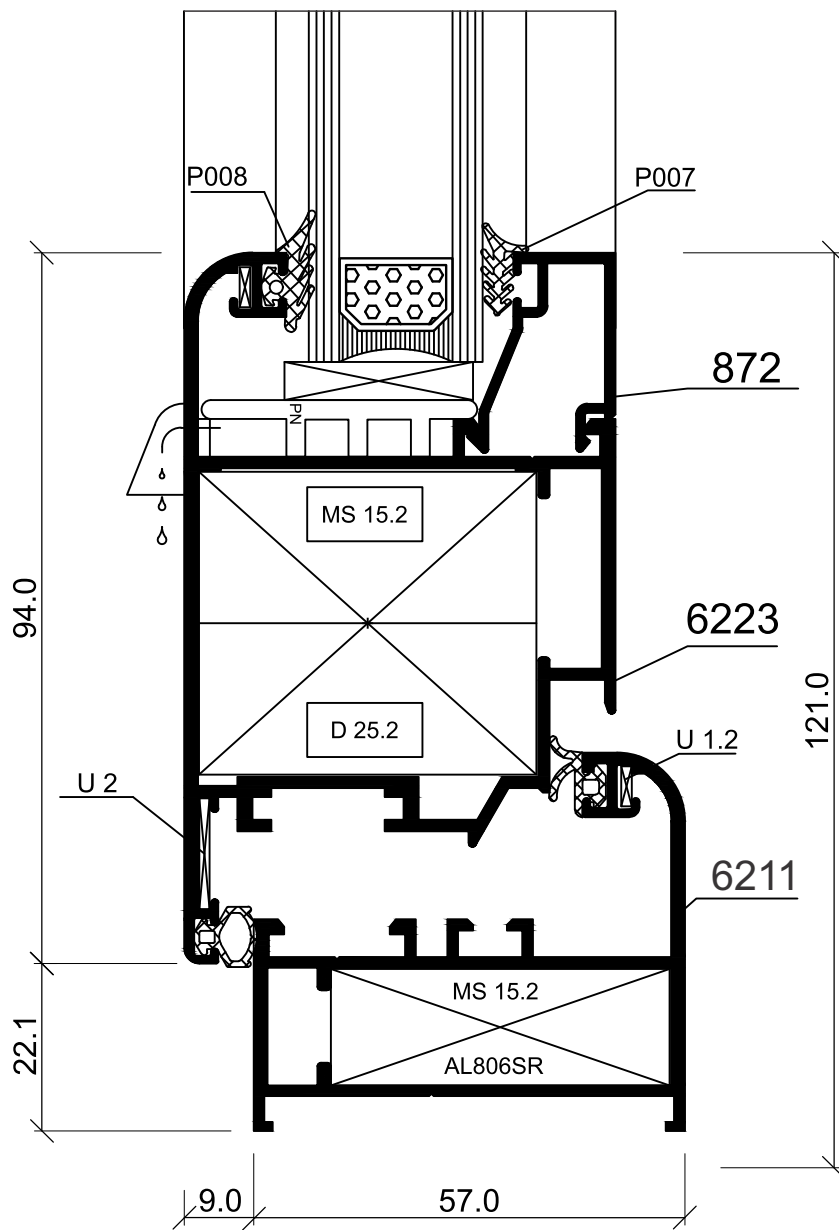
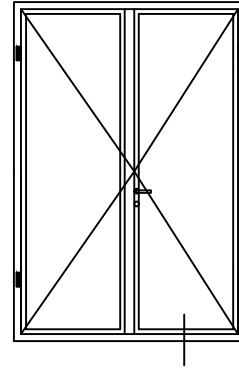

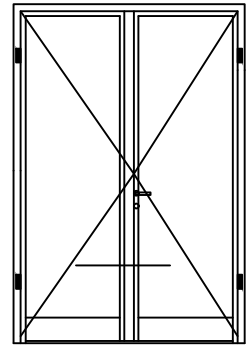
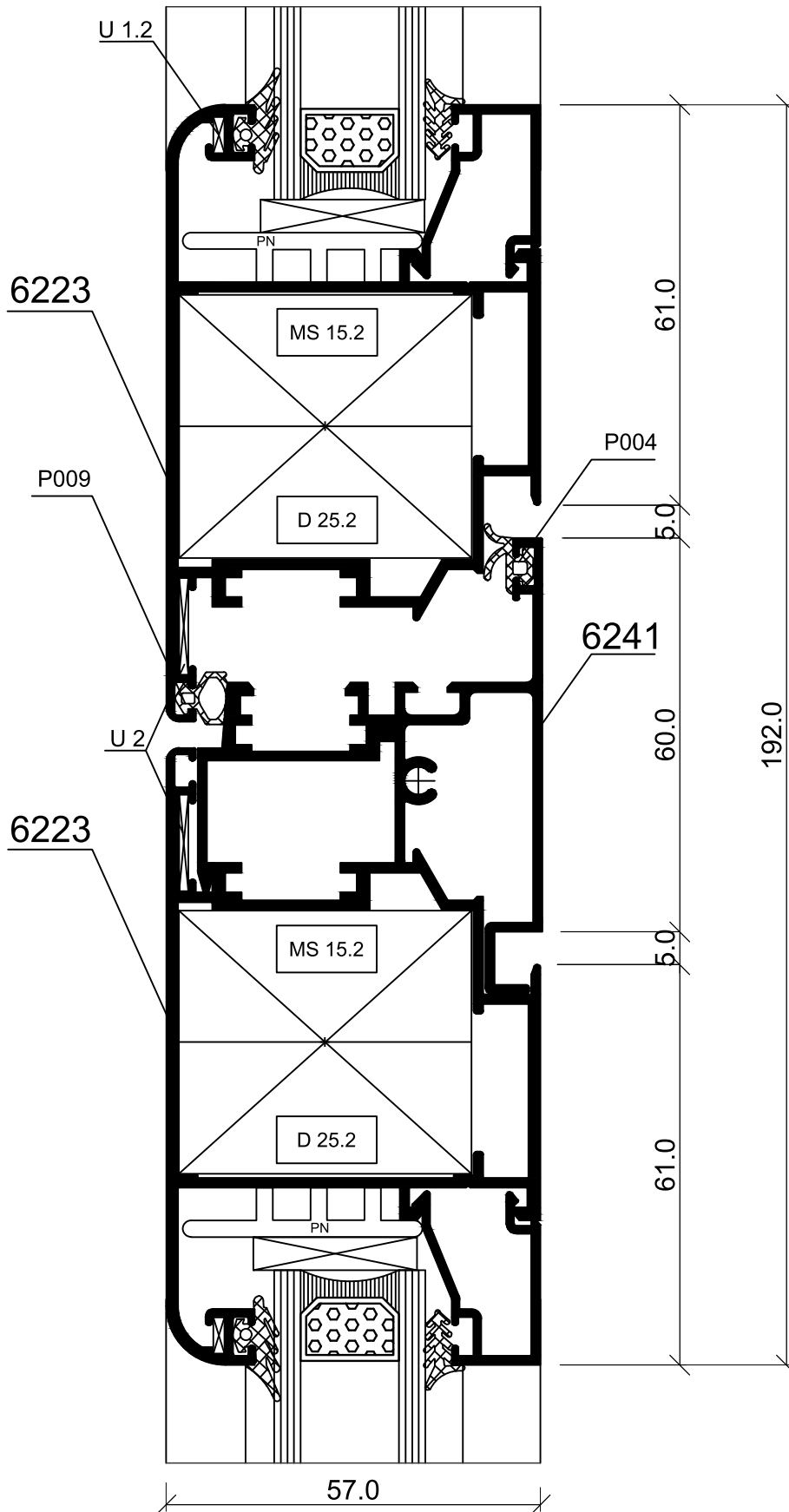

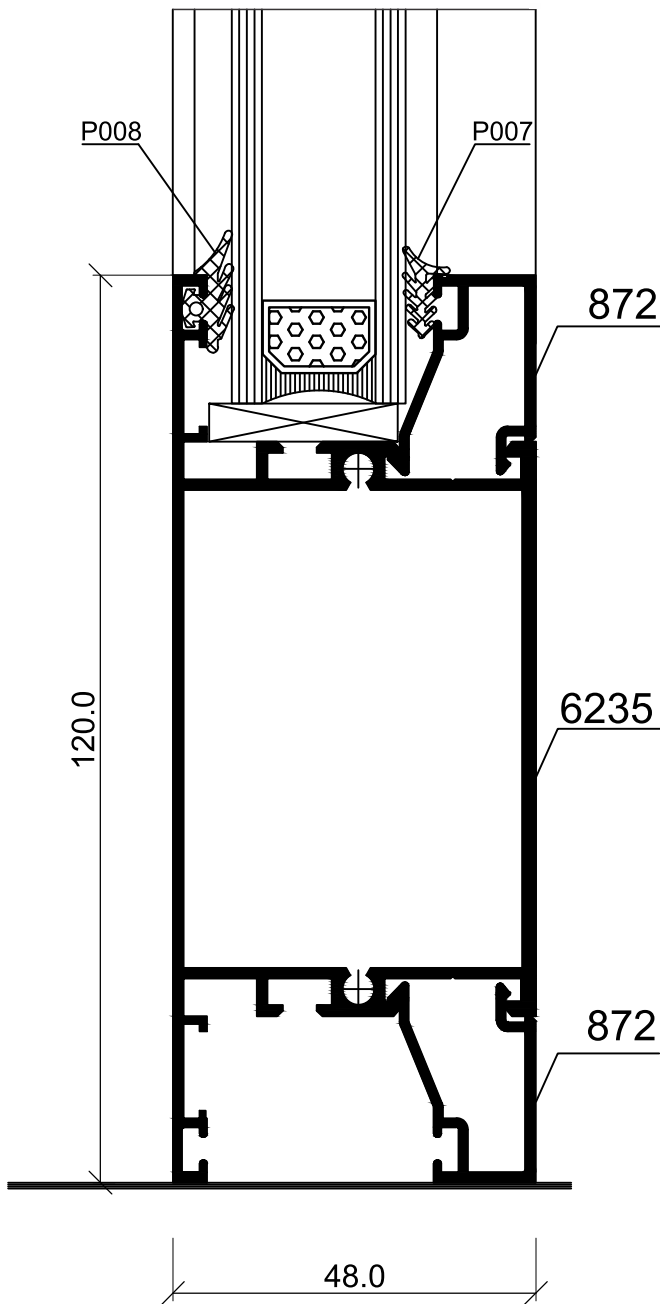
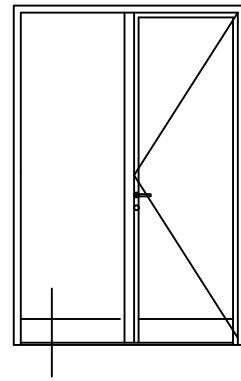

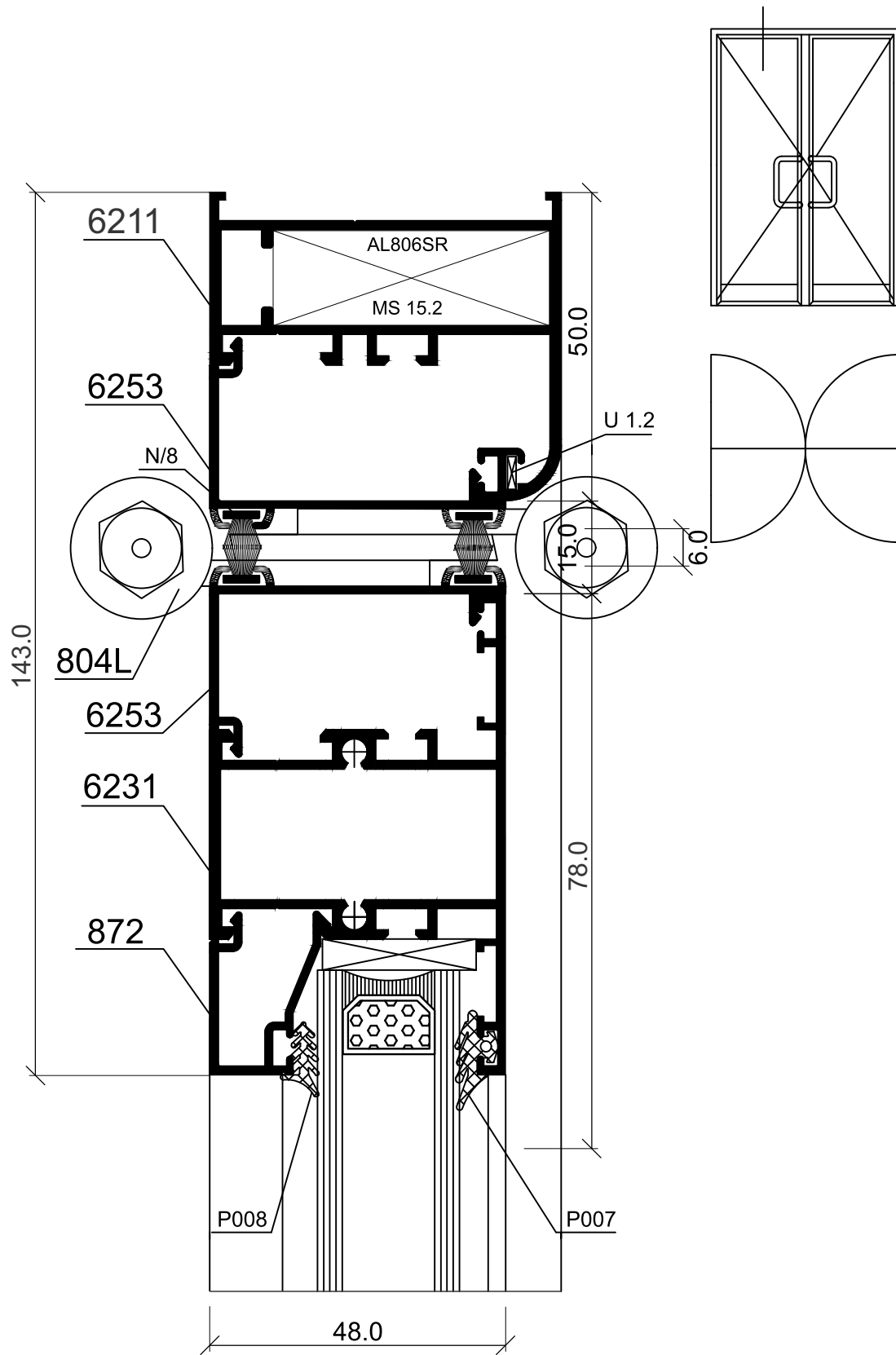

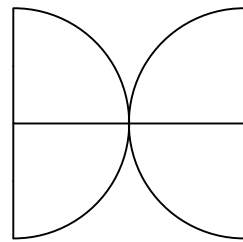
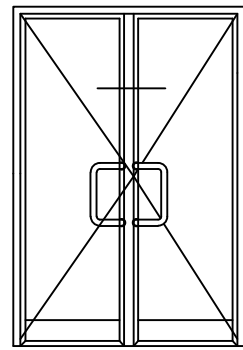
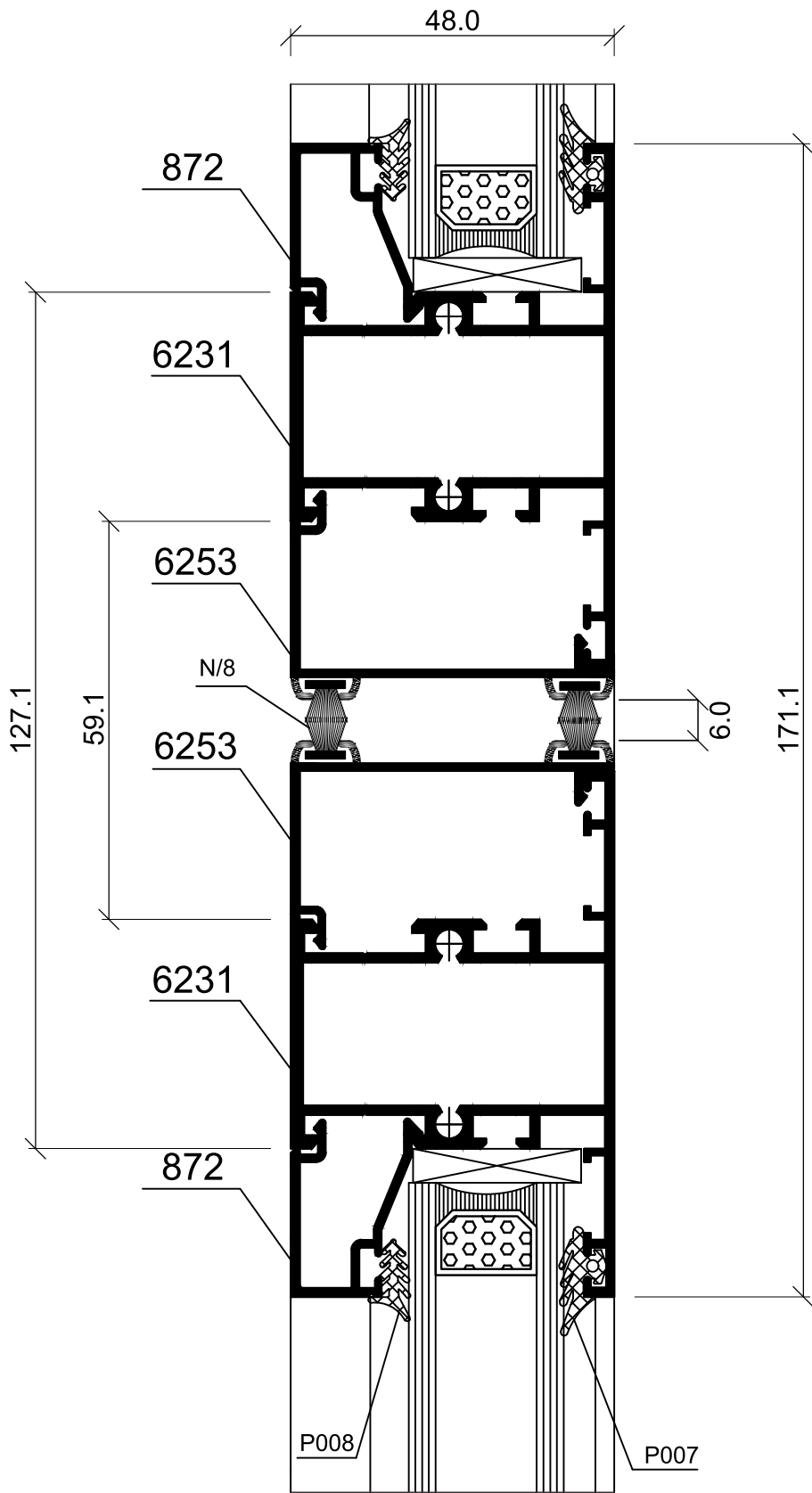

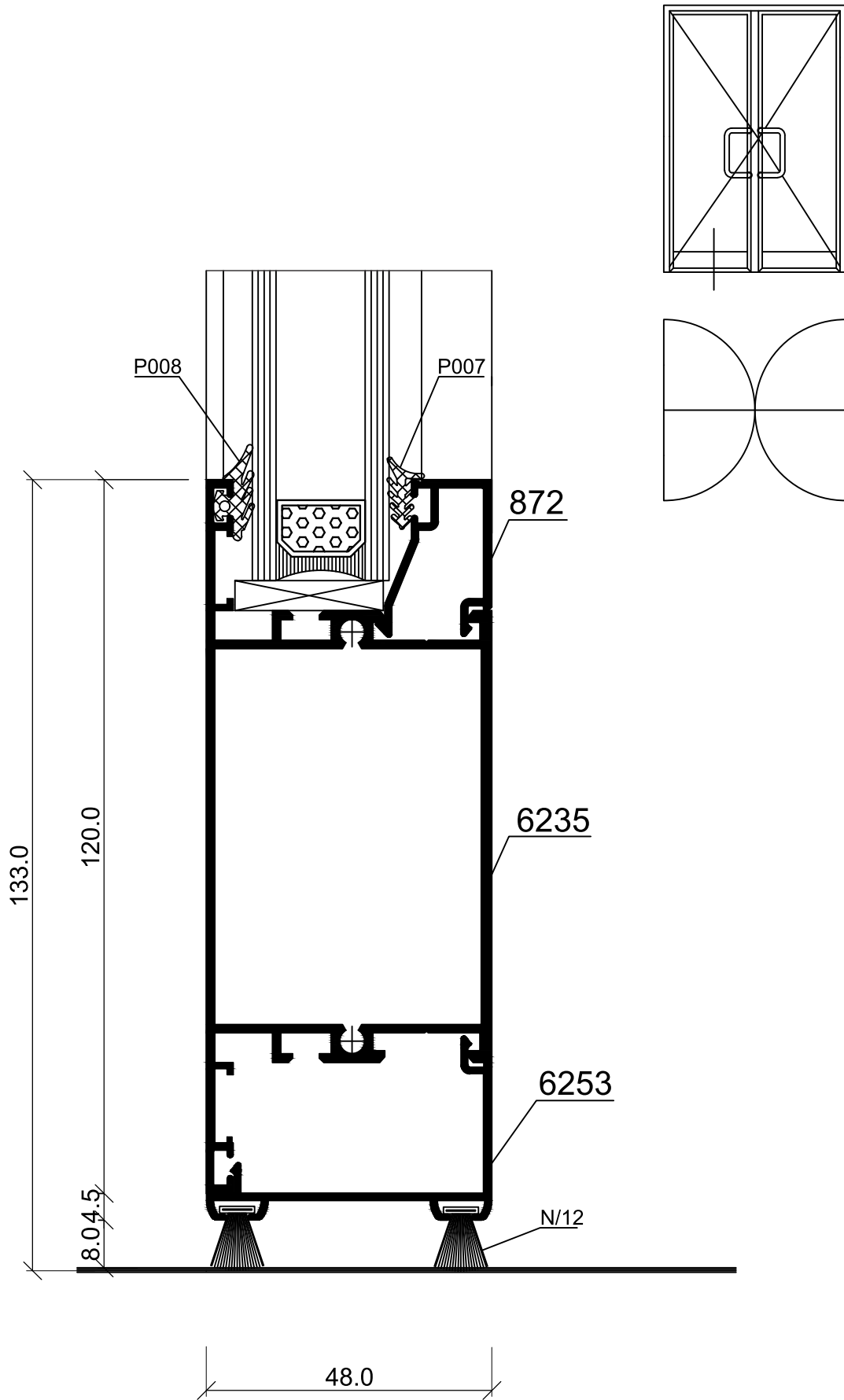

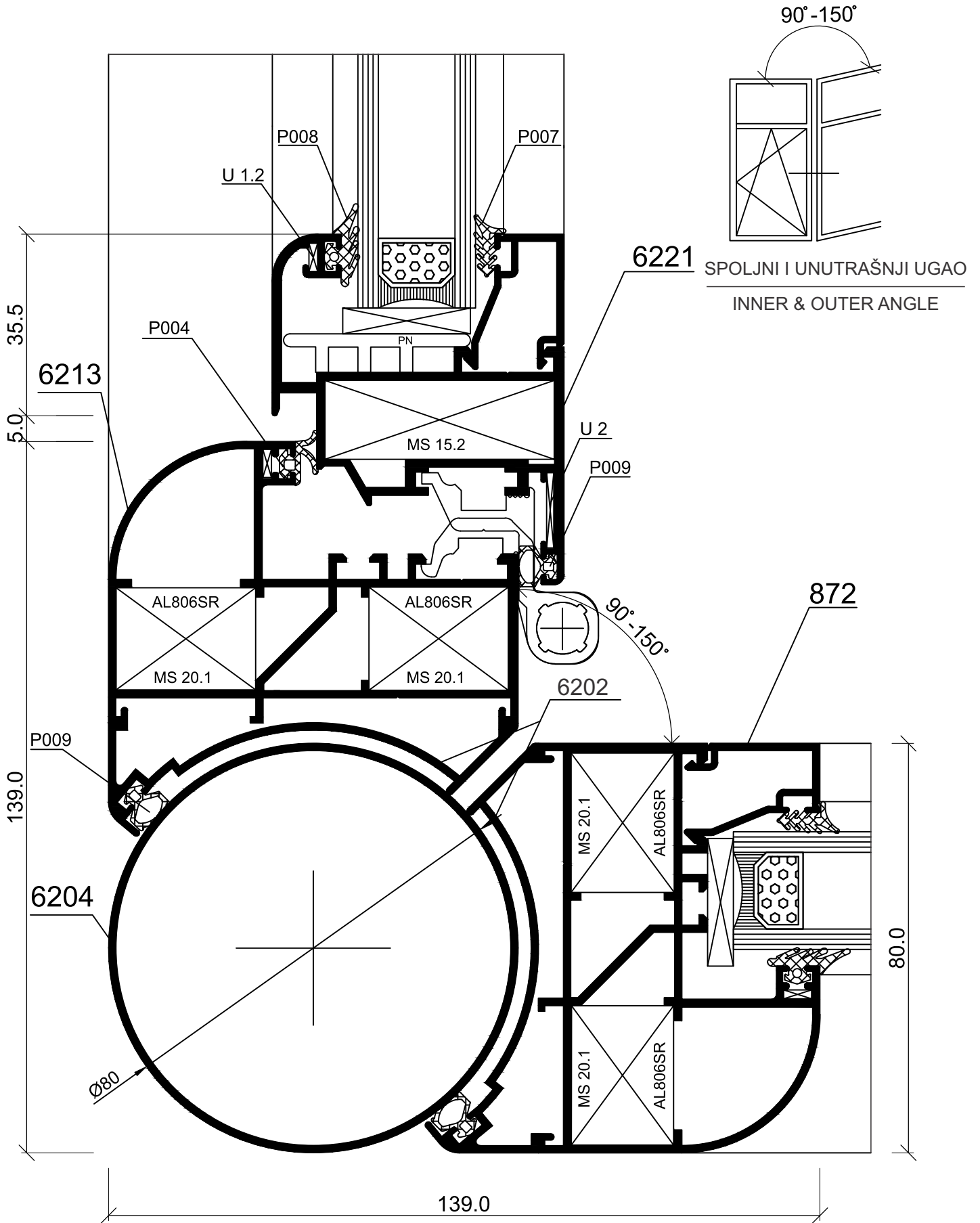

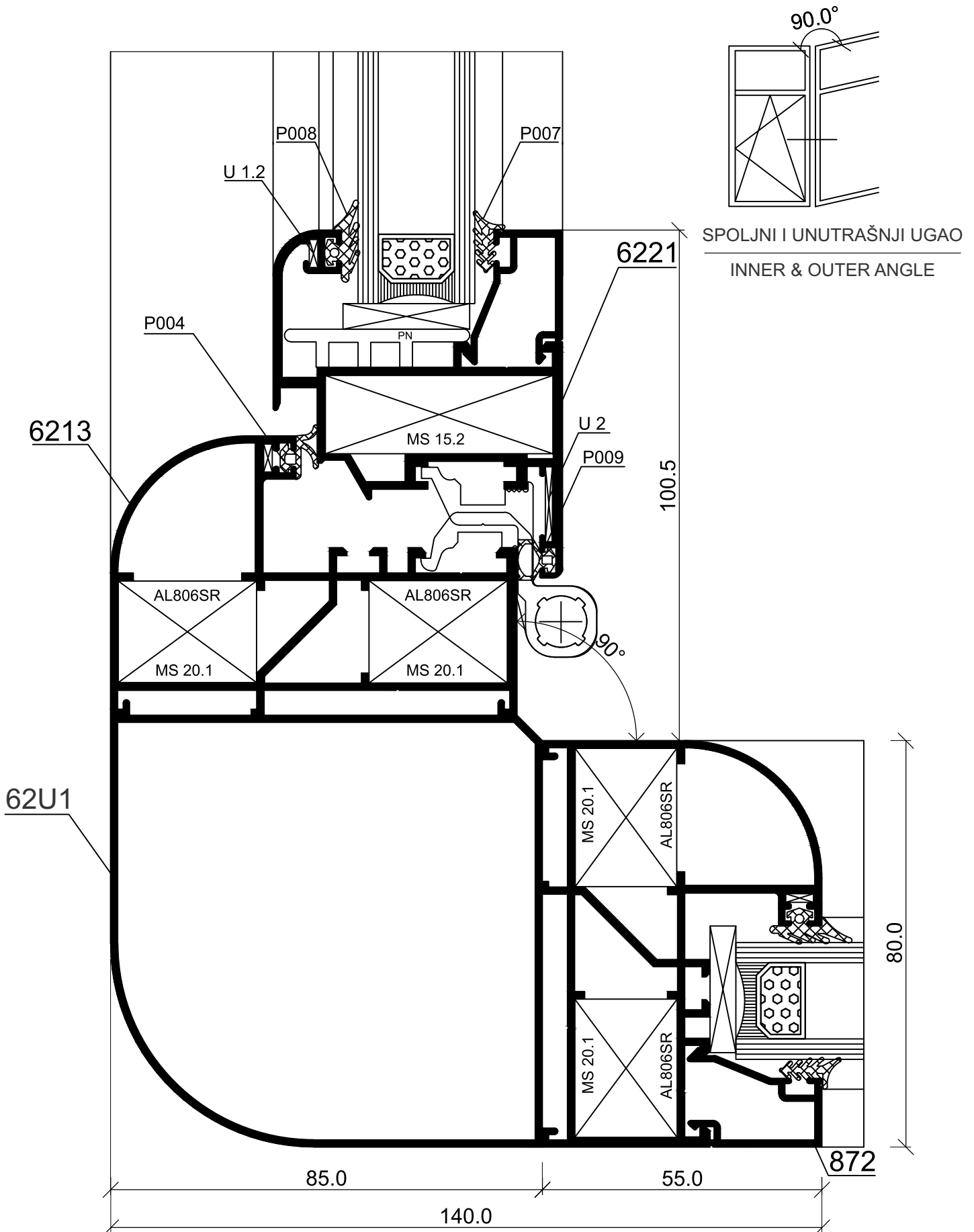

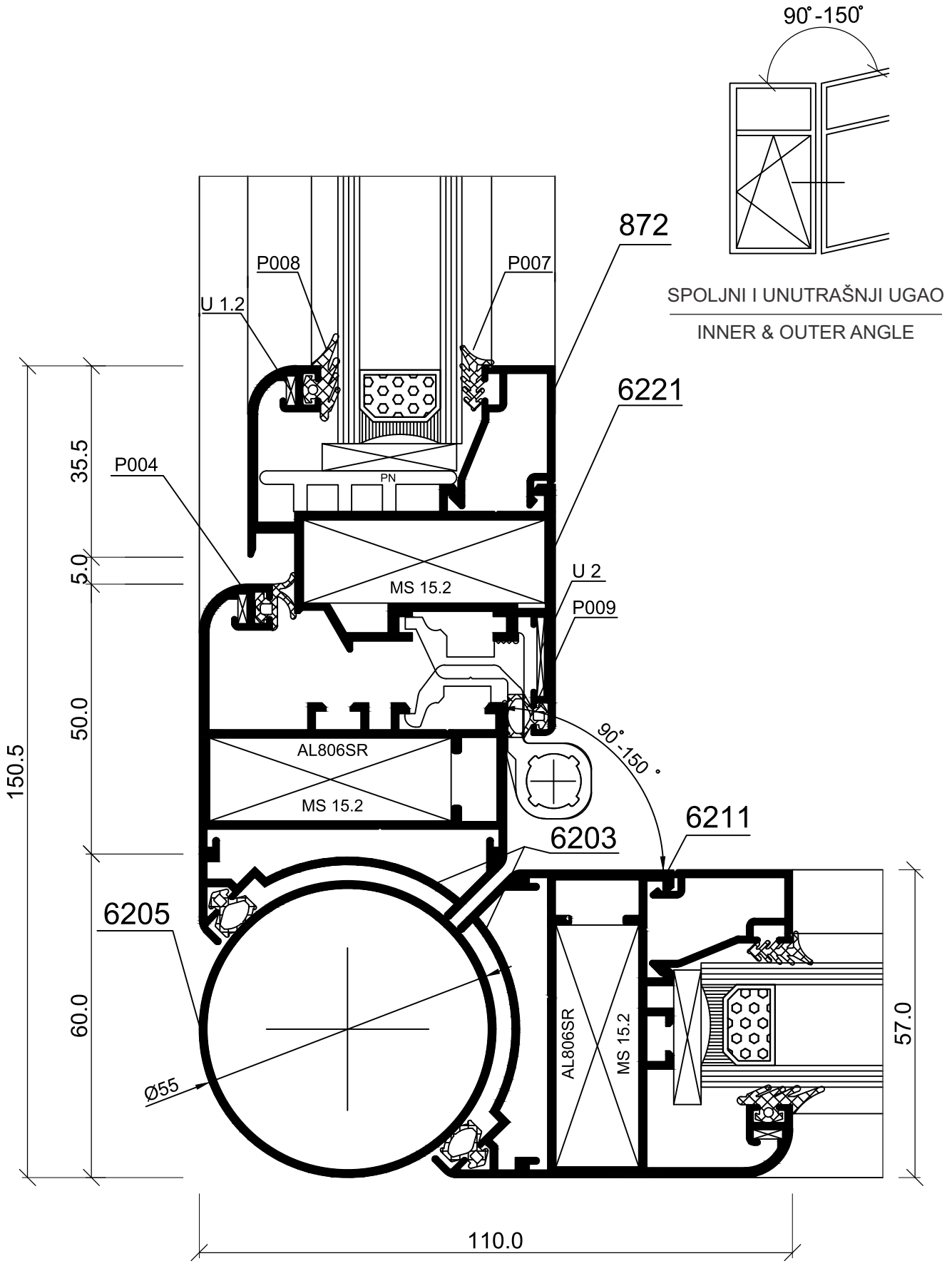

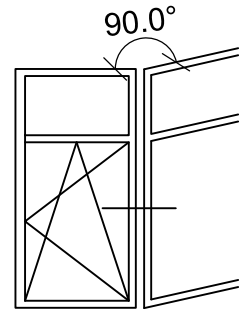

SPOLJNI I UNUTRAŠNJI UGAO
INNER & OUTER ANGLE

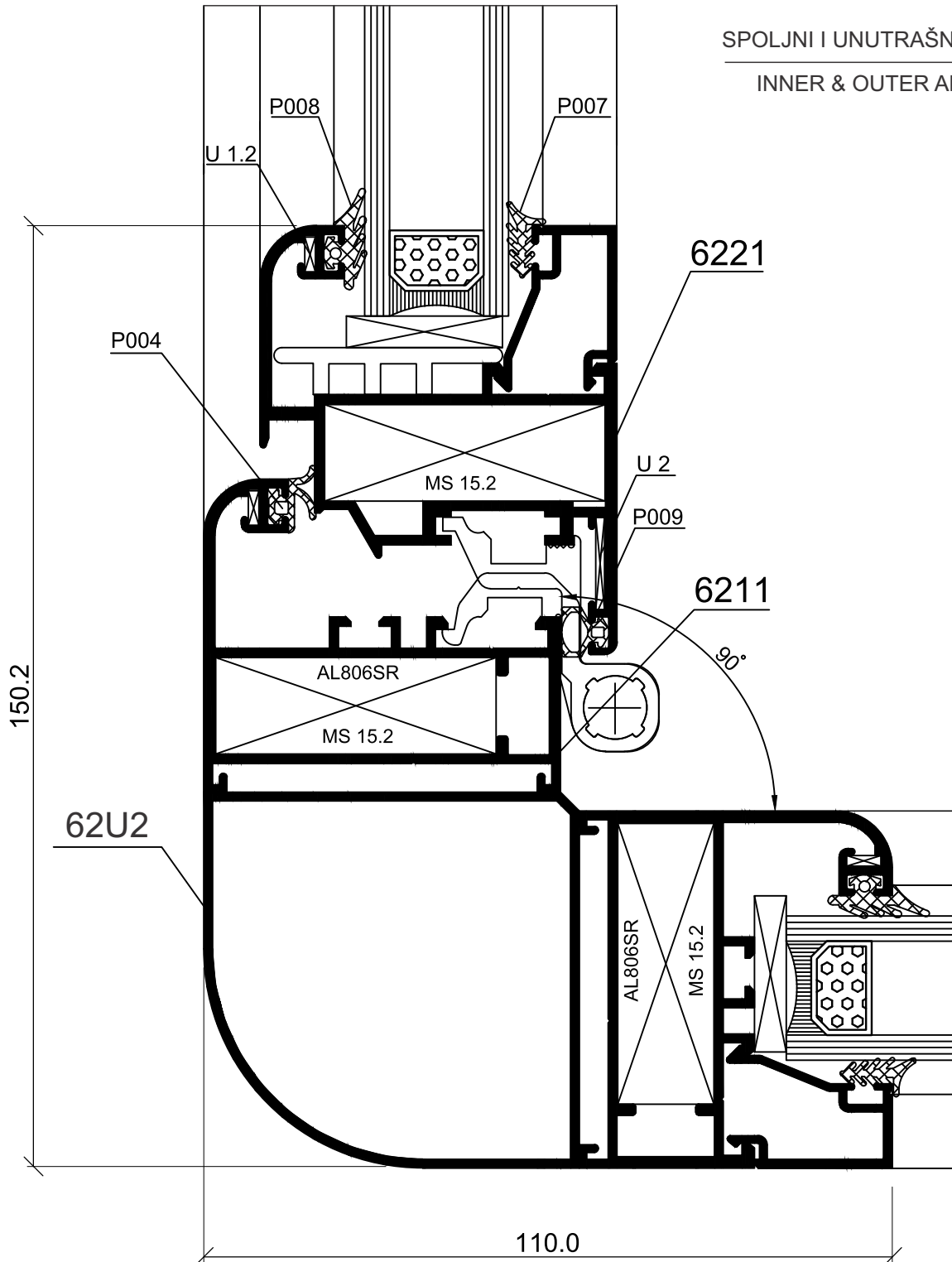

4706
Lajsna
Glazing bead
0.300 Kg/m'

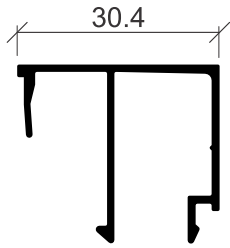

25.1
Lajsna
Glazing bead
0.295 Kg/m'



1835
Lajsna
Glazing bead
0.275 Kg/m'

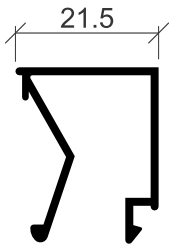

18.1
Lajsna
Glazing bead
0.255 Kg/m'

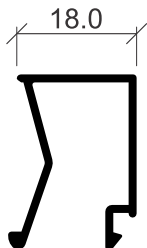

872
Lajsna
Glazing bead
0.250 Kg/m'

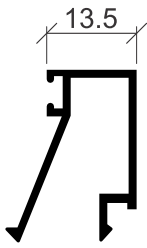

876
Lajsna
Glazing bead
0.250 Kg/m'



1836
Lajsna
Glazing bead
0.230 Kg/m'

