

SARAY[®]

all about **aluminium**

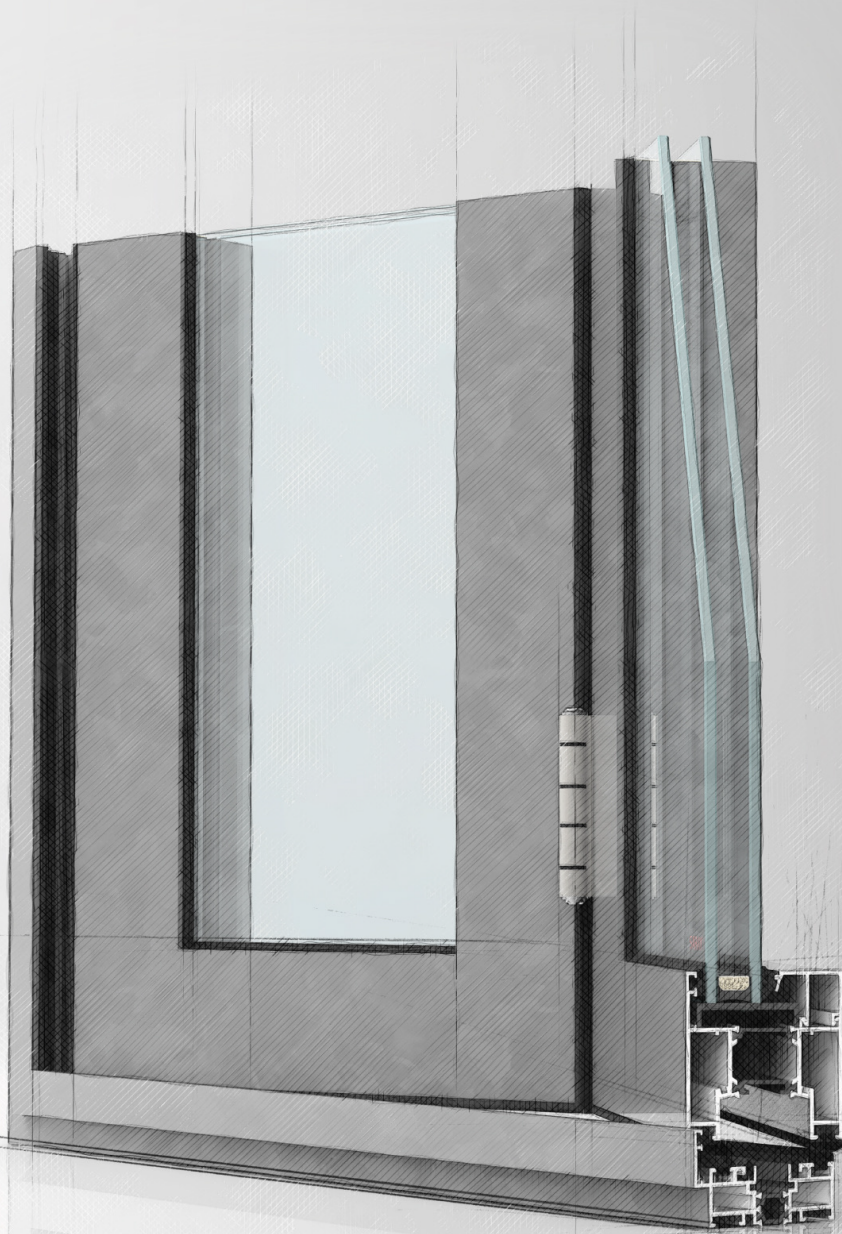

High performing and enduring
system for calm interiors

**PANORAMA KATLANIR KAPI
TEKNİK LİSTESİ**
PANORAMA FOLDING DOOR
TECHNICAL INDEX

> İÇİNDEKİLER / INDEX

TEKNİK ÖZELLİKLER / TECHNICAL PROPERTIES : 3 - 6

> PROFİLLER / PROFILES

PROFİL FİHRİSTİ / PROFILE INDEX : 9 - 10

SİSTEM PROFİLLERİ / SYSTEM PROFILES : 23 - 30

CAM ÇİTALARI / GLAZING BEADS : 28

CAM ÇITA TABLOSU / GLAZING BEAD TABLE : 29

> AKSESUARLAR / ACCESSORIES

EPDM FİTİLLER / EPDM GASKETS : 13

KÖŞE TAKOZLARI / EPDM GASKETS : 30

AKSESUAR FİHRİSTİ / PVC ACCESSORY INDEX : 13 - 20

> DETAYLAR / DETAILS

KATLANIR KAPI SİSTEM DETAYLARI /
FOLDING DOOR SYSTEM DETAILS : 33 - 62

İMALAT KESİM ÖLÇÜLERİ / FABRICATION CUTTING SIZES : 65 - 76

İMALAT DETAYLARI / FABRICATION DETAILS : 79 - 91



TEKNİK ÖZELLİKLER TECHNICAL PROPERTIES

KASA DERİNLİĞİ / FRAME DEPTH :	77 mm
KANAT DERİNLİĞİ / SASH DEPTH :	77 mm
PROFİL ET KALINLIĞI / PROFILE WALL THICKNESS :	1,6 mm - 2 mm
MAX. CAM KALINLIĞI / MAX. GLASS THICKNESS :	53 mm
ISI BARIYERLERİ / INSULATION BARS :	20 mm - 32 mm

MAKSİMUM KANAT YÜKSEKLİĞİ MAXIMUM SASH HEIGHT

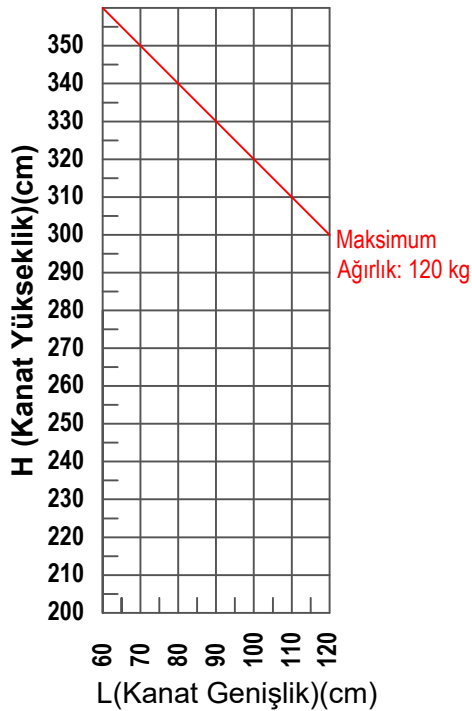

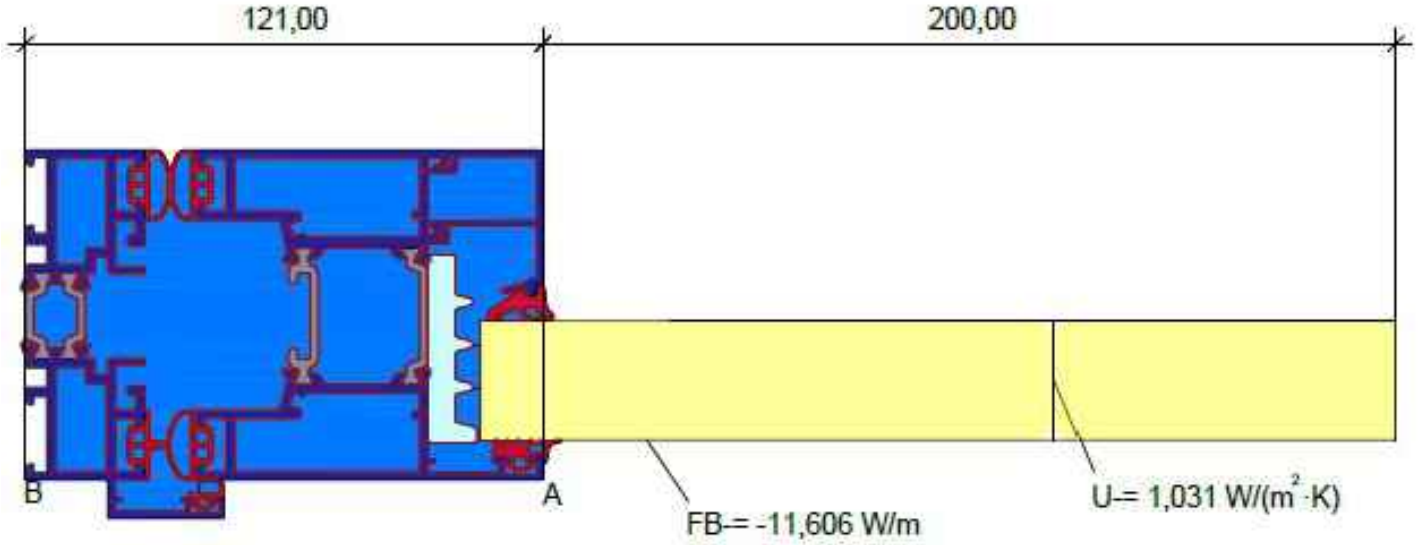

$$U_{FAB} = \frac{\Phi}{DT} = \frac{11,606}{20,000} - 1,031 \cdot 0,200 = 3,09 \text{ W/(m} \cdot \text{K)}$$

Material	λ [W/(m·K)]	ϵ	Boundary Condition	q [W/m ²]	q [C]	R [(m·K)/W]	ϵ
Aluminium (Si Alloys)	160,000	0,900	Epsilon 0.9				0,900
EPDM (ethylene propylene diene monomer)	0,250	0,900	Exterior, frame	0,000		0,040	
Panel	0,035	0,900	Interior, frame, normal	20,000		0,130	
Polyamid 6.6 with 25% glass fibre	0,300	0,900	Interior, frame, reduced	20,000		0,200	
Unventilated air cavity	anisotropic		Symmetry/Model section	0,000			
pe sunger	0,038	0,900					

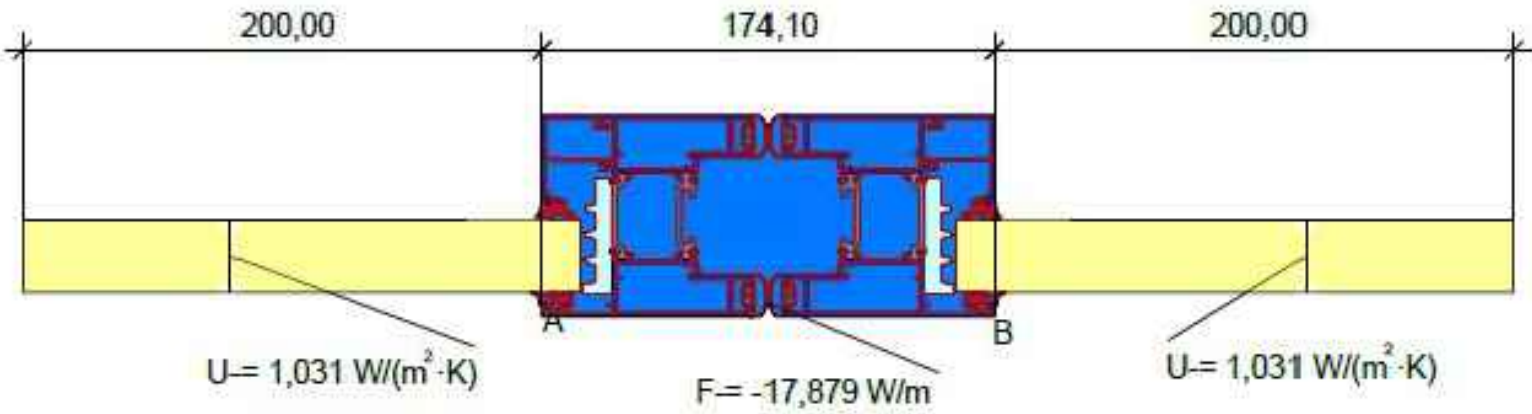

$$U_{f,A,B} = \frac{\Phi}{DT} = \frac{17,879}{20,000} = 0,894$$









$$U_{f,A,B} = \frac{17,879}{0,174} = 102,75 \text{ W}/(\text{m}^2 \cdot \text{K})$$

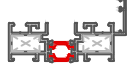
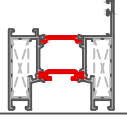
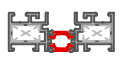
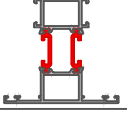
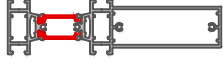

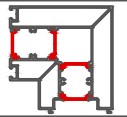
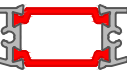
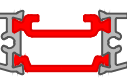

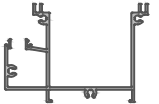





$$U_{f,A,B} = 1,031 \cdot 0,200 + 102,75 \cdot 0,174 = 18,05 \text{ W}/(\text{m}^2 \cdot \text{K})$$

$$U_{f,A,B} = 2,77 \text{ W}/(\text{m}^2 \cdot \text{K})$$









Material	λ [W/(m·K)]	ϵ	Boundary Condition	q [W/m ²]	T [°C]	R [(m ² ·K)/W]	ϵ
Aluminium (Si Alloys)	160,000	0,900	Epsilon 0.9				0,900
EPDM (ethylene propylene diene monomer)	0,250	0,900	Exterior, frame	0,000		0,040	
Panel	0,035	0,900	Interior, frame, normal	20,000		0,130	
Polyamid 6.6 with 25% glass fibre	0,300	0,900	Interior, frame, reduced	20,000		0,200	
Unventilated air cavity	anisotropic		Symmetry/Model section	0,000			
pe sunger	0,038	0,900					

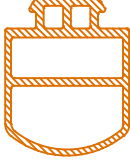

PANORAMA KATLANIR KAPI
PROFİL LİSTESİ
PANORAMA FOLDING DOOR
PROFILES INDEX

PROFİL NUM. PROFILE NO.	TANIM DESCRIPTION	ÇİZİM DRAWING	SAYFA PAGE
P 3000	KASA PROFİLİ FRAME PROFILE		23
P 3001	KANAT PROFİLİ SASH PROFILE		23
P 3002	KASA PROFİLİ FRAME PROFILE		24
P 3003	ORTA KAYIT PROFİLİ MULLION PROFILE		24
P 3004	TAKVİYELİ ORTA KAYIT PROFİLİ REINFORCEMENT MULLION PROFILE		25
P 3018	ADAPTÖR PROFİLİ ADAPTER PROFILE		25
P 3019	ADAPTÖR PROFİLİ ADAPTER PROFILE		25
P 3007	90° KÖŞE DÖNÜŞ PROFİLİ 90° CORNER PROFILE		26
P 3005	ADAPTÖR PROFİLİ ADAPTER PROFILE		26
P 3006	ADAPTÖR PROFİLİ ADAPTER PROFILE		26
P 3022	EŞİK PROFİLİ THRESHOLD PROFILE		27
P 2328	SU KANALI PROFİLİ WATER CHANNEL PROFILE		27
P 2327	ÜST IZGARA PROFİLİ TOP GRILLE PROFILE		27
P 1497	40 mm CAM ÇITA PROFİLİ 40 mm GLAZING BEAD PROFILE		28
P 1498	36 mm CAM ÇITA PROFİLİ 36 mm GLAZING BEAD PROFILE		28

PROFİL NUM. PROFILE NO.	TANIM DESCRIPTION	ÇİZİM DRAWING	SAYFA PAGE
P 1158	31 mm CAM ÇITA PROFİLİ 31 mm GLAZING BEAD PROFILE		28
P 1180	27 mm CAM ÇITA PROFİLİ 27 mm GLAZING BEAD PROFILE		28
P 2167	22 mm CAM ÇITA PROFİLİ 22 mm GLAZING BEAD PROFILE		28
P 1179	18 mm CAM ÇITA PROFİLİ 18 mm GLAZING BEAD PROFILE		28
P 1176	14 mm CAM ÇITA PROFİLİ 14 mm GLAZING BEAD PROFILE		28
P 1494	10 mm CAM ÇITA PROFİLİ 10 mm GLAZING BEAD PROFILE		28
P 1495	6 mm CAM ÇITA PROFİLİ 6 mm GLAZING BEAD PROFILE		28
P 3020	ADAPTÖR PROFİLİ ADAPTER PROFILE		28
P 1163	KÖŞE TAKOZ PROFİLİ CORNER CLEAT PROFILE		30
P 3023	KÖŞE TAKOZ PROFİLİ CORNER CLEAT PROFILE		30

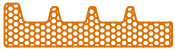

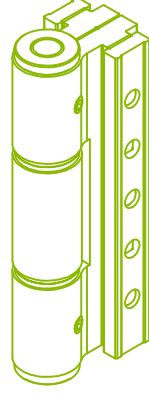
PANORAMA KATLANIR KAPI
FİTİL VE AKSESUARLAR
PANORAMA FOLDING DOOR
GASKETS AND ACCESSORIES

AKSESUAR KODU ACCESSORY CODE	MALZEME TANIMI DESCRIPTION	ÇİZİM DRAWING	MALZEME MATERIAL
800 271	İÇ CAM FİTİLİ 6 mm / INTERIOR GLAZING GASKET 6 mm KOLİ MİKTARI / PACKAGE QUANTITY: 192 m / Koli		EPDM EPDM
800 218	DIŞ CAM FİTİL / EXTERIOR GLAZING GASKET KOLİ MİKTARI / PACKAGE QUANTITY: 188 m / Koli		EPDM EPDM
800 101	BİNİ FİTİLİ /OVERLAP GASKET KOLİ MİKTARI / PACKAGE QUANTITY: 260 m / Koli		EPDM EPDM
800 103	BİNİ FİTİLİ /OVERLAP GASKET KOLİ MİKTARI / PACKAGE QUANTITY: 372 m / Koli		EPDM EPDM
800 104	KANAL KAPATMA FİTİLİ / CHANNEL CLOSING GASKET KOLİ MİKTARI / PACKAGE QUANTITY: 245 m / Koli		EPDM EPDM
800 105	BİNİ FİTİLİ /OVERLAP GASKET KOLİ MİKTARI / PACKAGE QUANTITY: 210 m / Koli		EPDM EPDM
800 112	BİNİ FİTİLİ /OVERLAP GASKET KOLİ MİKTARI / PACKAGE QUANTITY: 360 m / Koli		EPDM EPDM
800 113	BİNİ FİTİLİ /OVERLAP GASKET KOLİ MİKTARI / PACKAGE QUANTITY: 290 m / Koli		EPDM EPDM
800 111	İZOLASYON FİTİLİ /INSULATION GASKET KOLİ MİKTARI / PACKAGE QUANTITY: 270 m / Koli		EPDM EPDM

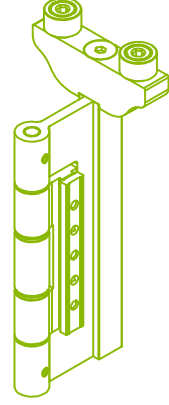
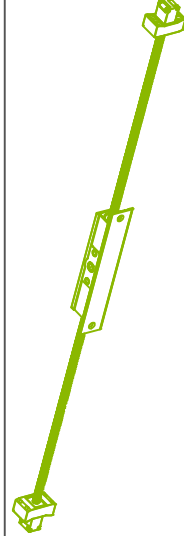
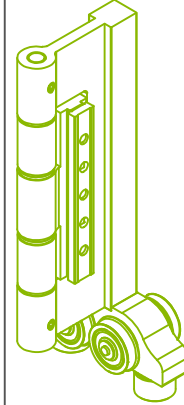

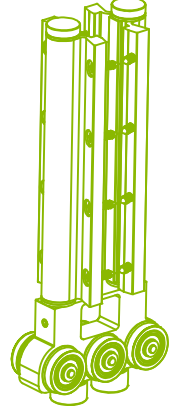
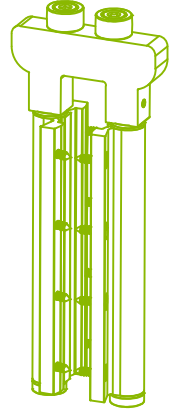
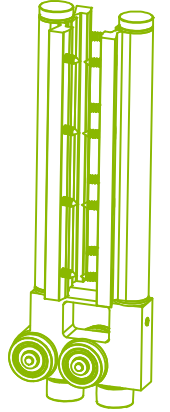

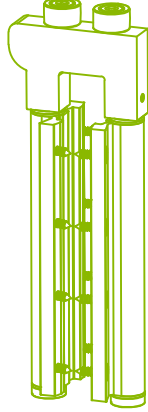
AKSESUAR KODU ACCESSORY CODE	MALZEME TANIMI DESCRIPTION	ÇİZİM DRAWING	MALZEME MATERIAL
702 201	KATLANIR KAPI MENTEŞE / FOLDING DOOR HINGE KOLİ MİKTARI / PACKAGE QUANTITY: 30 ad / Pieces		ALÜMİNYUM ALUMINIUM
702 202	KATLANIR KAPI ALT SON ARABA / FOLDING DOOR LOWER TROLLEY KOLİ MİKTARI / PACKAGE QUANTITY: 10 ad / Pieces		ALÜMİNYUM ALUMINIUM
702 203	KATLANIR KAPI ÜST SON ARABA / FOLDING DOOR UPPER TROLLEY KOLİ MİKTARI / PACKAGE QUANTITY: 10 ad / Pieces		ALÜMİNYUM ALUMINIUM

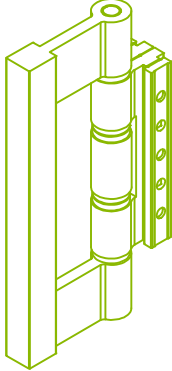
AKSESUAR KODU ACCESSORY CODE	MALZEME TANIMI DESCRIPTION	ÇİZİM DRAWING	MALZEME MATERIAL
702 204	KATLANIR KAPI ÜST ARA ARABA / FOLDING DOOR UPPER TROLLEY KOLİ MİKTARI / PACKAGE QUANTITY: 10 ad / Pieces		ALÜMİNYUM ALUMINIUM
702 205	KATLANIR KAPI KİLEME SETİ / FOLDING DOOR LOCKING SET KOLİ MİKTARI / PACKAGE QUANTITY: 5 ad / Pieces		ALÜMİNYUM ALUMINIUM
702 206	KATLANIR KAPI ALT ARA ARABA / FOLDING DOOR LOWER TROLLEY KOLİ MİKTARI / PACKAGE QUANTITY: 10 ad / Pieces		ALÜMİNYUM ALUMINIUM

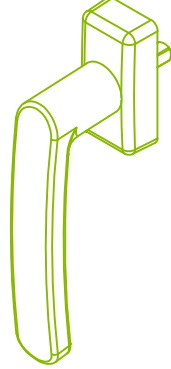
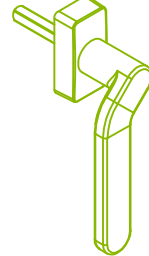
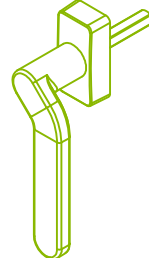
AKSESUAR KODU ACCESSORY CODE	MALZEME TANIMI DESCRIPTION	ÇİZİM DRAWING	MALZEME MATERIAL
702 207	KATLANIR KAPI ALT ARA ARABA-TAKVİYELİ 150 KG / FOLDING DOOR LOWER TROLLEY - REINFORCED KOLİ MİKTARI / PACKAGE QUANTITY: 10 ad / Pieces		ALÜMİNYUM ALUMINIUM
702 208	KATLANIR KAPI ÜST ARA ARABA-TAKVİYELİ / FOLDING DOOR UPPER TROLLEY-REINFORCED KOLİ MİKTARI / PACKAGE QUANTITY: 10 ad / Pieces		ALÜMİNYUM ALUMINIUM
702 209	KATLANIR KAPI ALT SON TAŞIYICI ARABA 150 KG / FOLDING DOOR END CARRIAGE 150 KG KOLİ MİKTARI / PACKAGE QUANTITY: 10 ad / Pieces		ALÜMİNYUM ALUMINIUM

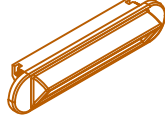
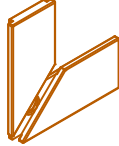
AKSESUAR KODU ACCESSORY CODE	MALZEME TANIMI DESCRIPTION	ÇİZİM DRAWING	MALZEME MATERIAL
702 210	KATLANIR KAPI ÜST SON ARABA-TAKVİYELİ / FOLDING DOOR UPPER TROLLEY-REINFORCED KOLİ MİKTARI / PACKAGE QUANTITY: 10 ad / Pieces		ALÜMİNYUM ALUMINIUM
702 211	130 mm MİNİMAL KOL / 130 mm HANDLE KOLİ MİKTARI / PACKAGE QUANTITY: 10 ad / Pieces		ALÜMİNYUM ALUMINIUM
702 220	KATLANIR KAPI MENTEŞE (ÇEKME KOLLU) / FOLDING DOOR HINGE (FOR PULL) KOLİ MİKTARI / PACKAGE QUANTITY: 10 ad / Pieces		ALÜMİNYUM ALUMINIUM

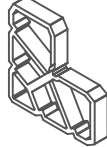
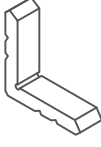
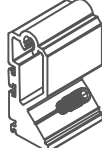
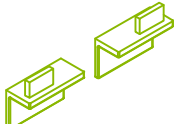
AKSESUAR KODU ACCESSORY CODE	MALZEME TANIMI DESCRIPTION	ÇİZİM DRAWING	MALZEME MATERIAL
700 830	140 mm DÜZ KOL (90° Stoplamalı) / 140 mm HANDLE (90° Stopping) KOLİ MİKTARI / PACKAGE QUANTITY: 10 ad / Pieces		ALÜMİNYUM ALUMINIUM
700 832	SOLA KIVRIK KOL / TO THE LEFT CURLED HANDLE KOLİ MİKTARI / PACKAGE QUANTITY: 10 ad / Pieces		ALÜMİNYUM ALUMINIUM
700 833	SAĞA KIVRIK KOL / TO THE RIGHT CURLED HANDLE KOLİ MİKTARI / PACKAGE QUANTITY: 10 ad / Pieces		ALÜMİNYUM ALUMINIUM

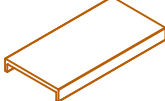
AKSESUAR KODU ACCESSORY CODE	MALZEME TANIMI DESCRIPTION	ÇİZİM DRAWING	MALZEME MATERIAL
702 214	SU TAHLİYE KAPAĞI / WATER DRAINAGE HOLE CAP KOLİ MİKTARI / PACKAGE QUANTITY: 50 ad / Koli		PVC PVC
702 215	KÖŞE ÇAVUŞU / CORNER JOINT KOLİ MİKTARI / PACKAGE QUANTITY: 100 ad / Koli		PVC PVC
700 988	SU KANALI PROFİLİ YAN KAPAK / SIDE CAP FOR WATER CHANNELPROFILE KOLİ MİKTARI / PACKAGE QUANTITY: 20 ad / Koli		ALÜMİNYUM ALUMINIUM
702 216	ALÜMİNYUM KÖŞE TAKOZU / 42,6 mm L :12 mm ALUMINIUM CORNER CLEAT KOLİ MİKTARI / PACKAGE QUANTITY: 20 ad / Koli		ALÜMİNYUM ALUMINIUM
702 217	ALÜMİNYUM KÖŞE TAKOZU / 11,5 mm L :20,2 mm ALUMINIUM CORNER CLEAT KOLİ MİKTARI / PACKAGE QUANTITY: 20 ad / Koli		ALÜMİNYUM ALUMINIUM
702 218	DİK BAĞLANTI 25,6 mm / T CONNECTION 25,6 mm KOLİ MİKTARI / PACKAGE QUANTITY: 20 ad / Pieces		ALÜMİNYUM ALUMINIUM
702 219	ADAPTÖR ALT ve ÜST KAPAĞI / ADAPTER BOTTOM and TOP CAP KOLİ MİKTARI / PACKAGE QUANTITY: 50 ad / Pieces		PVC PVC
702 212	İNOKS RAY / INOX (STAINLESS STEEL) RAIL KOLİ MİKTARI / PACKAGE QUANTITY: 60 m (6 m x 10 pcs)/ Pieces		İNOKS INOX
702 213	CAM TAKOZU / GLAZING WEDGE KOLİ MİKTARI / PACKAGE QUANTITY: 50 ad / Pieces		PVC PVC

**PANORAMA KATLANIR KAPI
SİSTEM PROFİLLERİ**
PANORAMA FOLDING DOOR
SYSTEM PROFILES

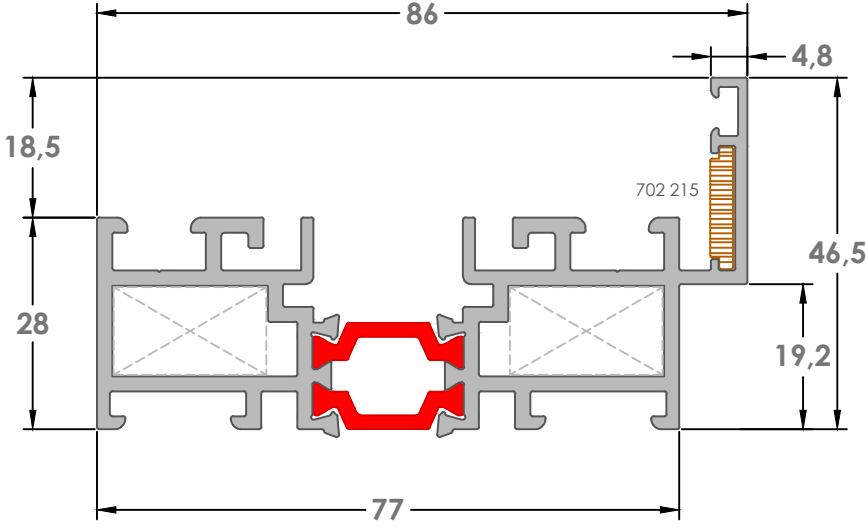

P 3000

JX
(cm⁴)
47,764

JY
(cm⁴)
6,522

AĞIRLIK / WEIGHT

(KG/M)
1,872
t = 2 MM

KÖŞE TAKOZLARI CORNER CLEATS

TAKOZ
P 1163 (11,5X20,2)

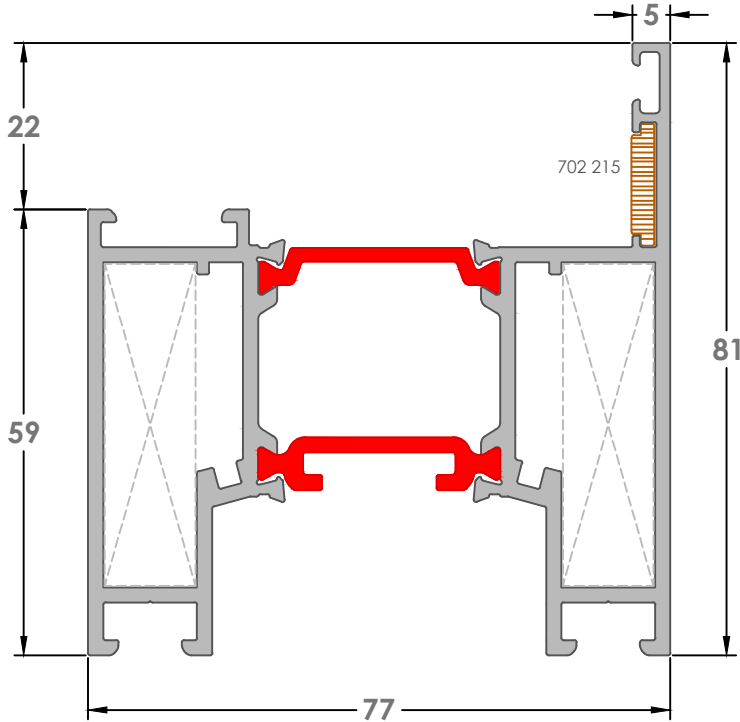

P 3001

JX
(cm⁴)
65,046

JY
(cm⁴)
30,401

AĞIRLIK / WEIGHT

(KG/M)
2,260
t = 2 MM

KÖŞE TAKOZLARI CORNER CLEATS

TAKOZ
P 3023 (42,6X12)

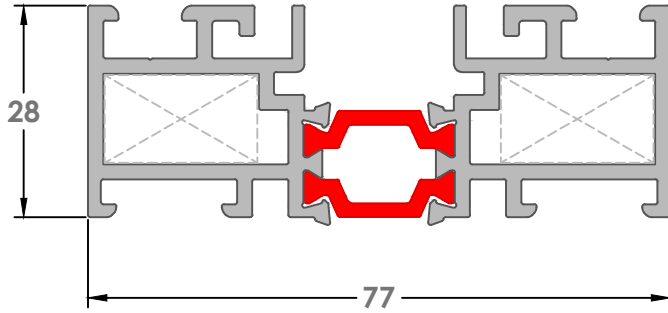

P 3002

JX
(cm⁴)
30,08



JY
(cm⁴)
4,17

AĞIRLIK / WEIGHT
(KG/M)
1,690
t = 2 MM

KÖŞE TAKOZLARI
CORNER CLEATS

TAKOZ
P 1163 (11,5X20,2)

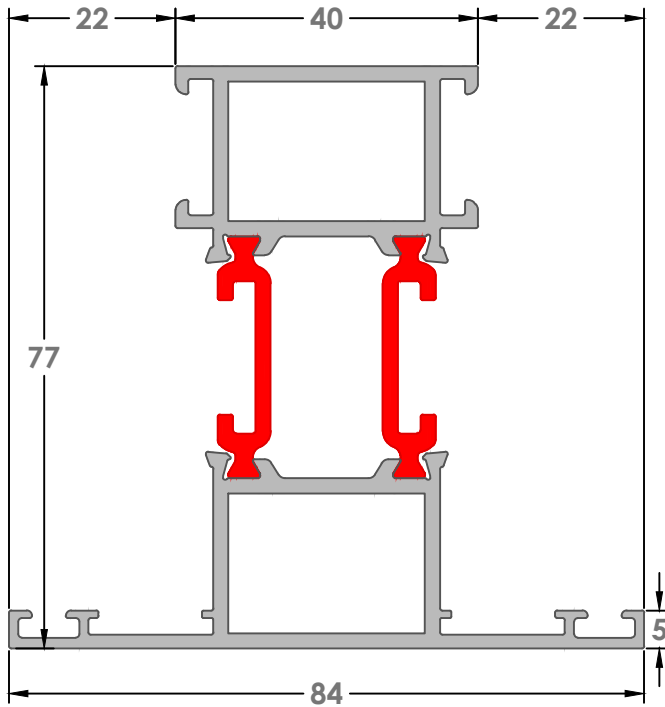

P 3003

JX
(cm⁴)
51,448



JY
(cm⁴)
17,935

AĞIRLIK / WEIGHT
(KG/M)
1,895
t = 2 MM

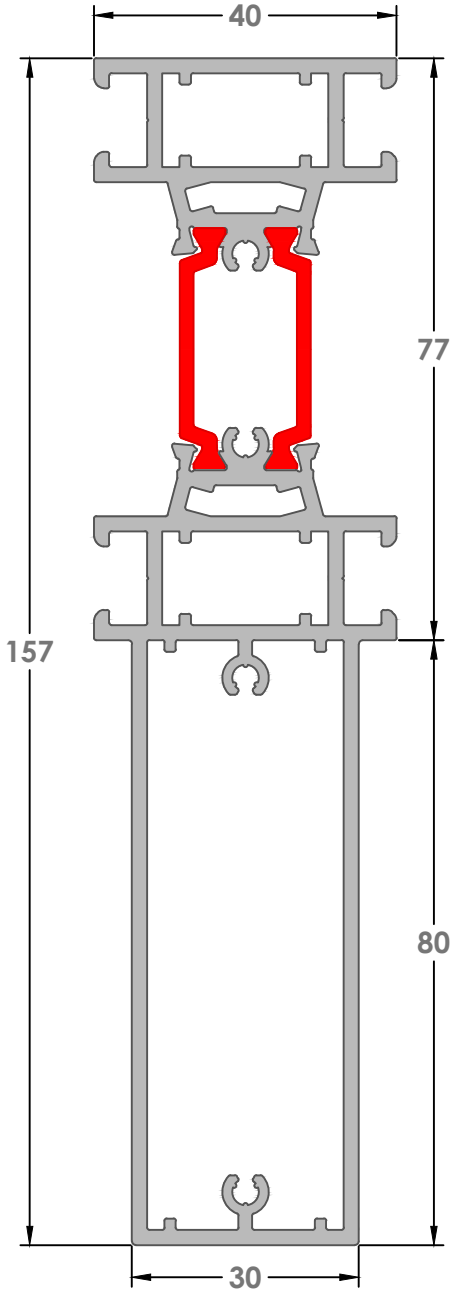

P 3004

JX (cm ⁴) 258,129	$\begin{array}{c} y \\ \\ x \end{array}$	JY (cm ⁴) 14,235
--	--	---

AĞIRLIK / WEIGHT
(KG/M)
3,110
t = 2 MM

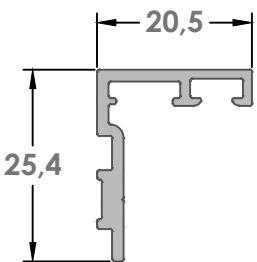

P 3018

JX (cm ⁴) 0,352	$\begin{array}{c} y \\ \\ x \end{array}$	JY (cm ⁴) 0,569
--	--	--

AĞIRLIK / WEIGHT
(KG/M)
0,250
t = 1,6 MM

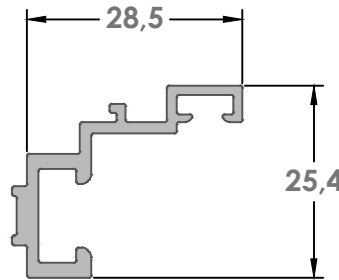

P 3019

JX (cm ⁴) 0,943	$\begin{array}{c} y \\ \\ x \end{array}$	JY (cm ⁴) 0,334
--	--	--

AĞIRLIK / WEIGHT
(KG/M)
0,330
t = 1,6 MM

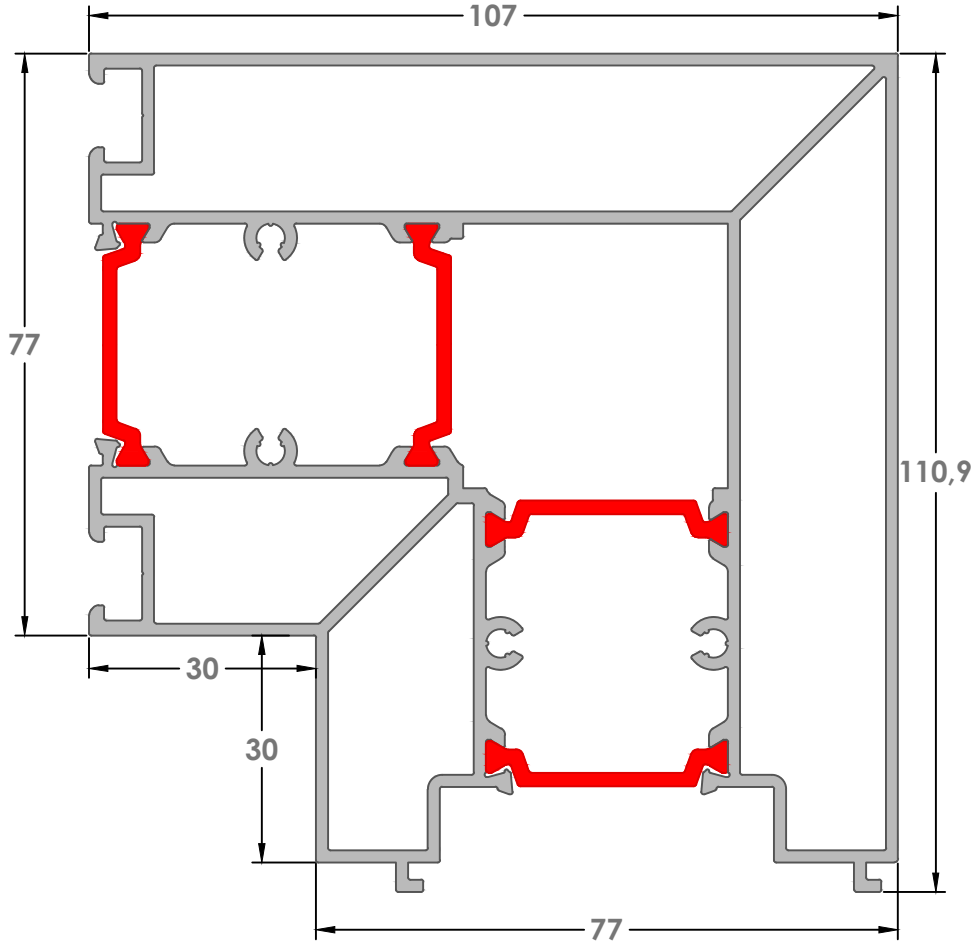

P 3007

JX (cm ⁴) 160,452	$\begin{array}{c} y \\ \hline x \\ \end{array}$	JY (cm ⁴) 153,937
--	--	--

AĞIRLIK / WEIGHT
(KG/M)
3,960
t = 1,6 MM

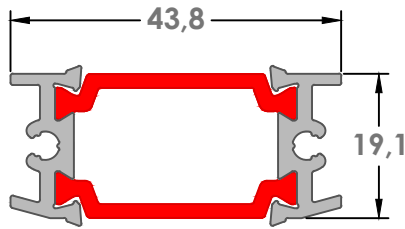

P 3005

JX (cm ⁴) 4,519	$\begin{array}{c} y \\ \hline x \\ \end{array}$	JY (cm ⁴) 0,649
--	--	--

AĞIRLIK / WEIGHT
(KG/M)
0,700
t = 1,6 MM

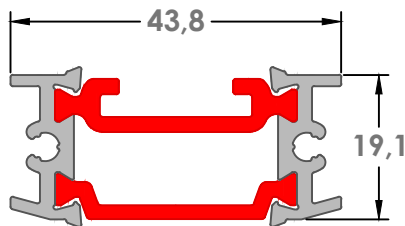

P 3006

JX (cm ⁴) 4,519	$\begin{array}{c} y \\ \hline x \\ \end{array}$	JY (cm ⁴) 0,649
--	--	--

AĞIRLIK / WEIGHT
(KG/M)
0,740
t = 1,6 MM

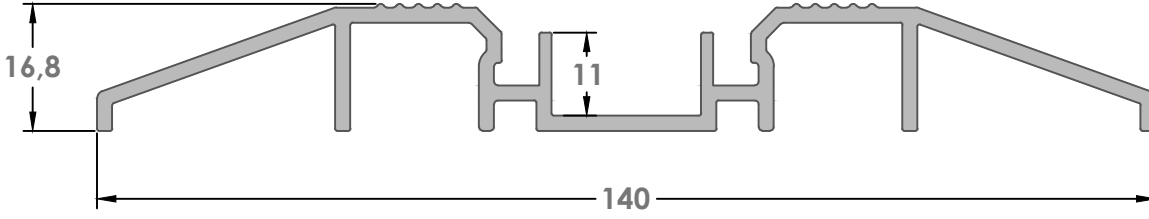

P 3022

JX
(cm⁴)
64,873

JY
(cm⁴)
1,183

AĞIRLIK / WEIGHT

(KG/M)
1,234
t = 2 MM

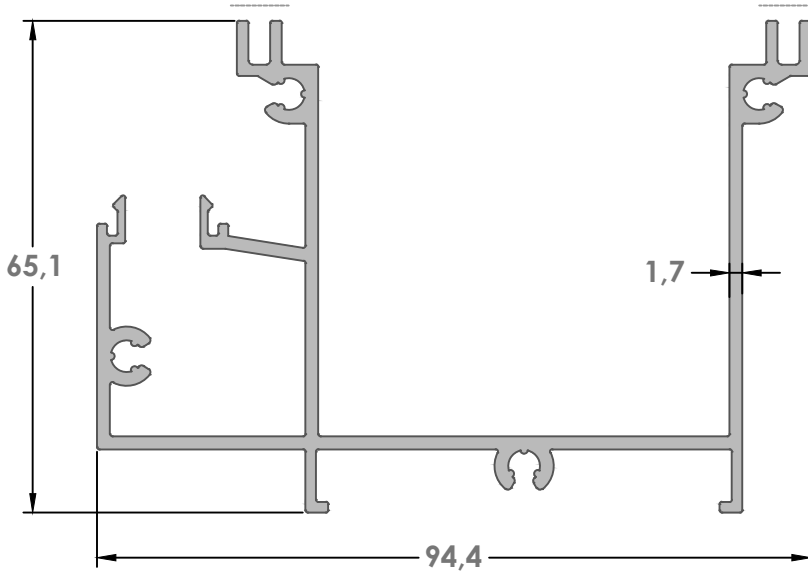

P 2328

AĞIRLIK / WEIGHT

(KG/M.)
0,380

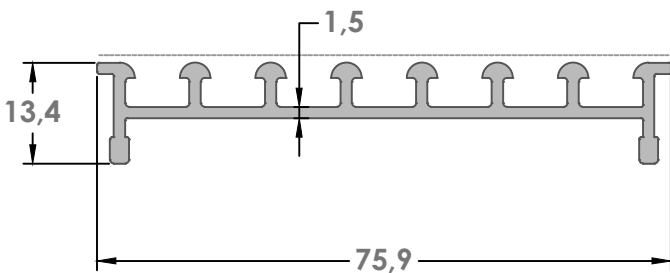

P 2327

AĞIRLIK / WEIGHT

(KG/M.)
0,635

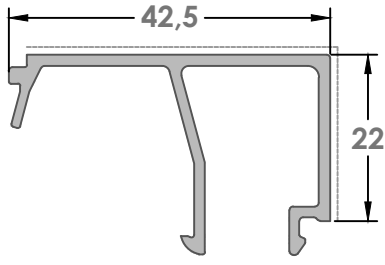

P 1497

AĞIRLIK / WEIGHT
(KG/M.)
0,435

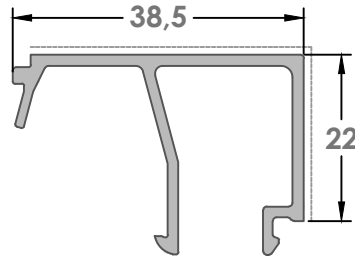

P 1498

AĞIRLIK / WEIGHT
(KG/M.)
0,415

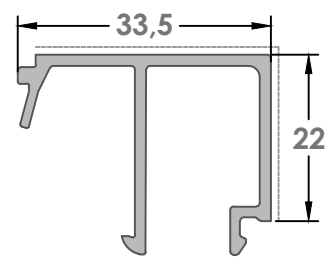

P 1158

AĞIRLIK / WEIGHT
(KG/M.)
0,365

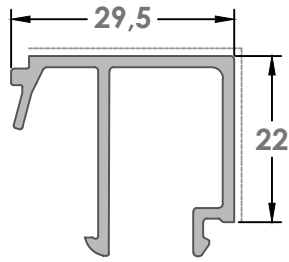

P 1180

AĞIRLIK / WEIGHT
(KG/M.)
0,380

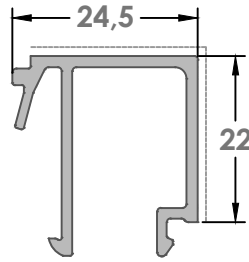

P 2167

AĞIRLIK / WEIGHT
(KG/M.)
0,355

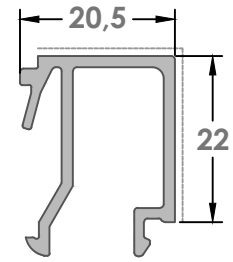

P 1179

AĞIRLIK / WEIGHT
(KG/M.)
0,350

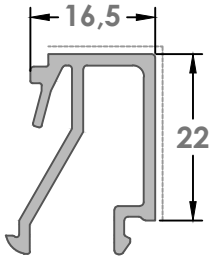

P 1176

AĞIRLIK / WEIGHT
(KG/M.)
0,335

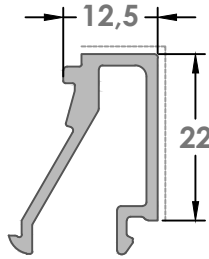

P 1494

AĞIRLIK / WEIGHT
(KG/M.)
0,325

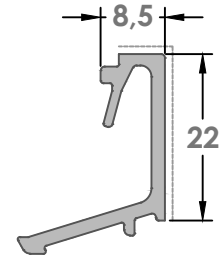

P 1495

AĞIRLIK / WEIGHT
(KG/M.)
0,270

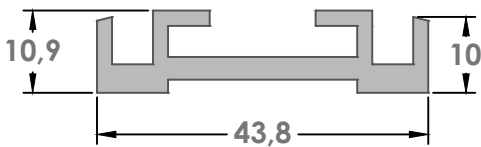

P 3020

AĞIRLIK / WEIGHT
(KG/M.)
0,595

Tabloda gösterilen conta ve boşluklar ile ilgili veriler teoriktir. Lütfen cam ve conta toleranslarının değişkenlik gösterebileceğini dikkate alınız.

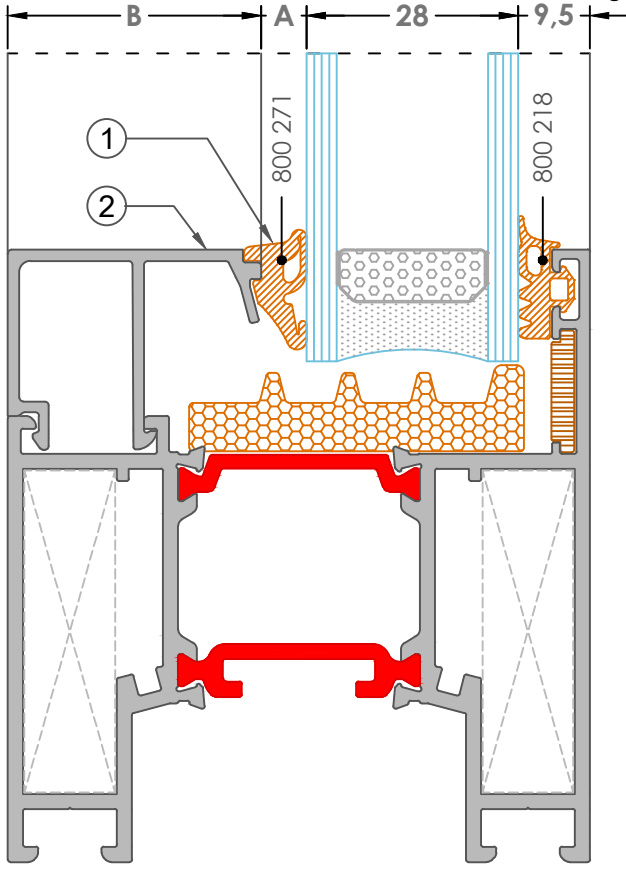

Tabloda gösterilen conta ve boşluklar ile ilgili veriler teoriktir. Lütfen cam ve conta toleranslarının değişkenlik gösterebileceğini dikkate alınız.

CAM MM	CONTA		ÇITA	
	A:MM	①	B:MM	②
19 MM	6 MM	800 271	40,1 MM	5525
23 MM	6 MM	800 271	36,1 MM	5525
28 MM	6 MM	800 271	31,1 MM	5570
32 MM	6 MM	800 271	27,1 MM	5571
37 MM	6 MM	800 271	22,1 MM	5570
41 MM	6 MM	800 271	18,1 MM	310
45 MM	6 MM	800 271	14,1 MM	342
49 MM	6 MM	800 271	10,1 MM	342
53 MM	6 MM	800 271	6,1 MM	342

CAM TAKOZLAMA TALİMATI

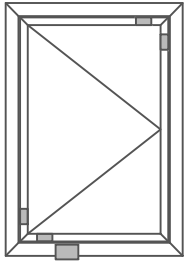

- CAM TAKOZU-cam takozlari yerlesimi üstte bulunan sematik çizimde gösterilmiştir. takozların kenara mesafeleri kanat ölçüsünün 5/1 i yada 10/1 i kadar olmalıdır.
- ▨ MESAFE AYARLAMA TAKOZU-mesafe ayar takozlari camin alüminyum çerçeve içinde doğru pozisyonda stabil olarak durmasını sağlar.Cam ile profil arasına takozlari zorlamadan yerleştiriniz.

Takozlar ahşap yada plastik malzemedan yapılabilir. cam takozu sertligi 70-75 shore mesafe ayarlama takozu sertligi 50-60 shore olmalıdır. takoz uzunlugu= Min. 50mm olmalıdır. takoz genisligi=cam kalınlıgından büyük olmalı,takoz kalınlıgı=belirtilen esit bosluk ölçülerinde

8,4 mm	DIŞ CONTA
800 271	800 218

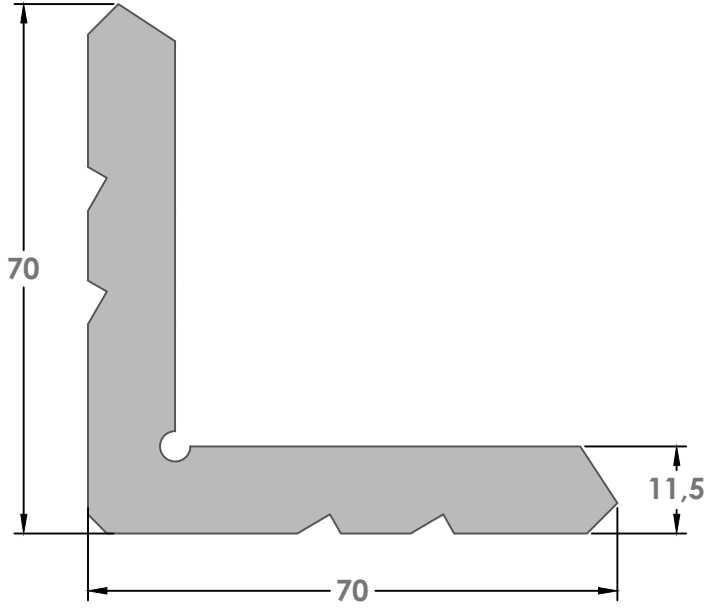

P 1163

AĞIRLIK / WEIGHT

(KG/M.)

3,750

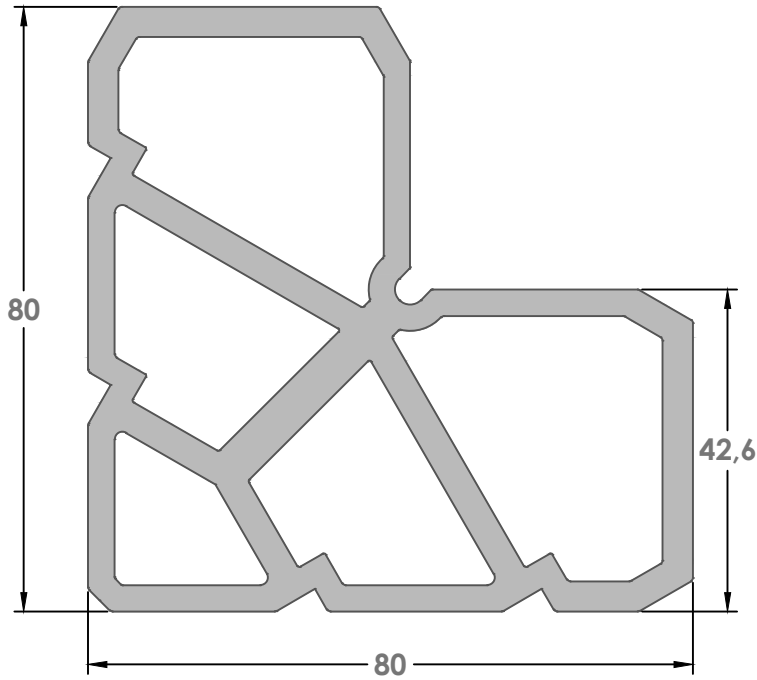

P 3023

AĞIRLIK / WEIGHT

(KG/M.)

4,590

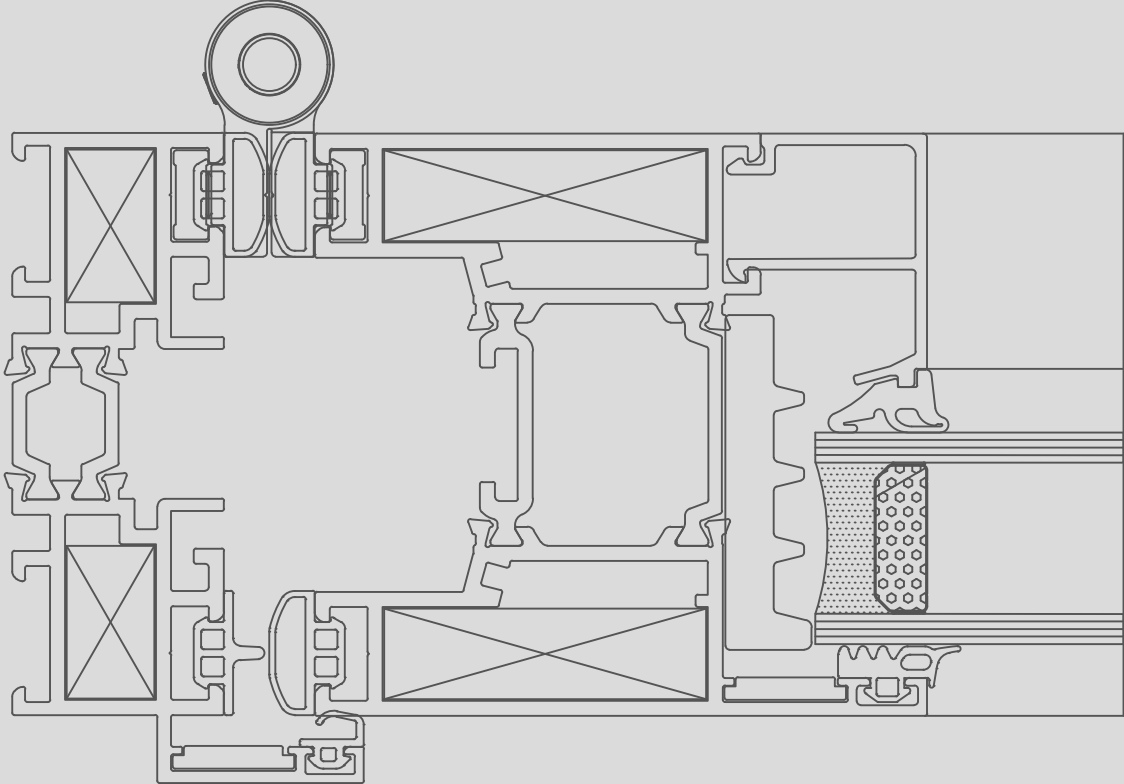

PANORAMA KATLANIR KAPI
DETYLARI
PANORAMA FOLDING DOOR
DETAILS

1K
Detay-Detail

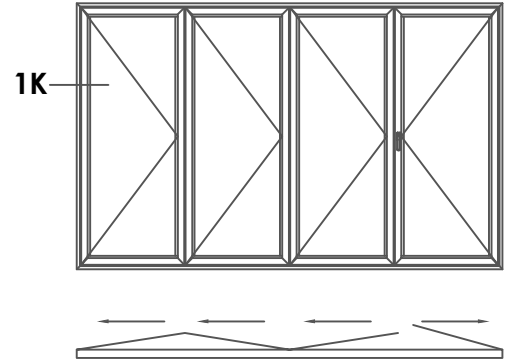

İÇ
INSIDE

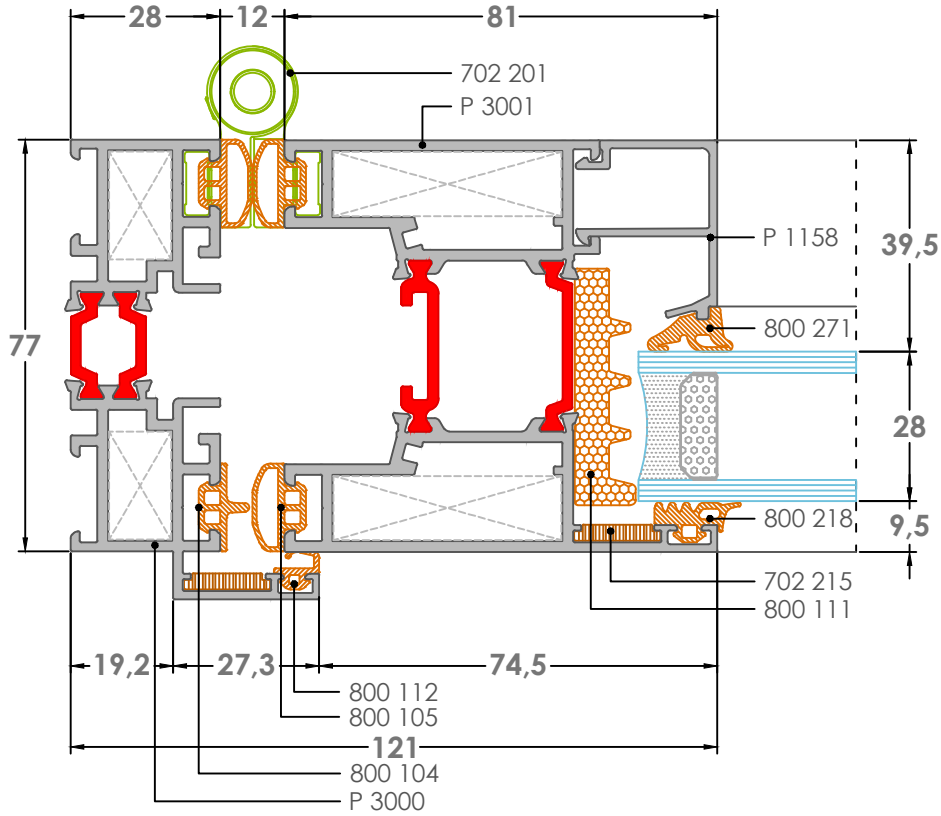

DIŞ
OUTSIDE

2K
Detay-Detail

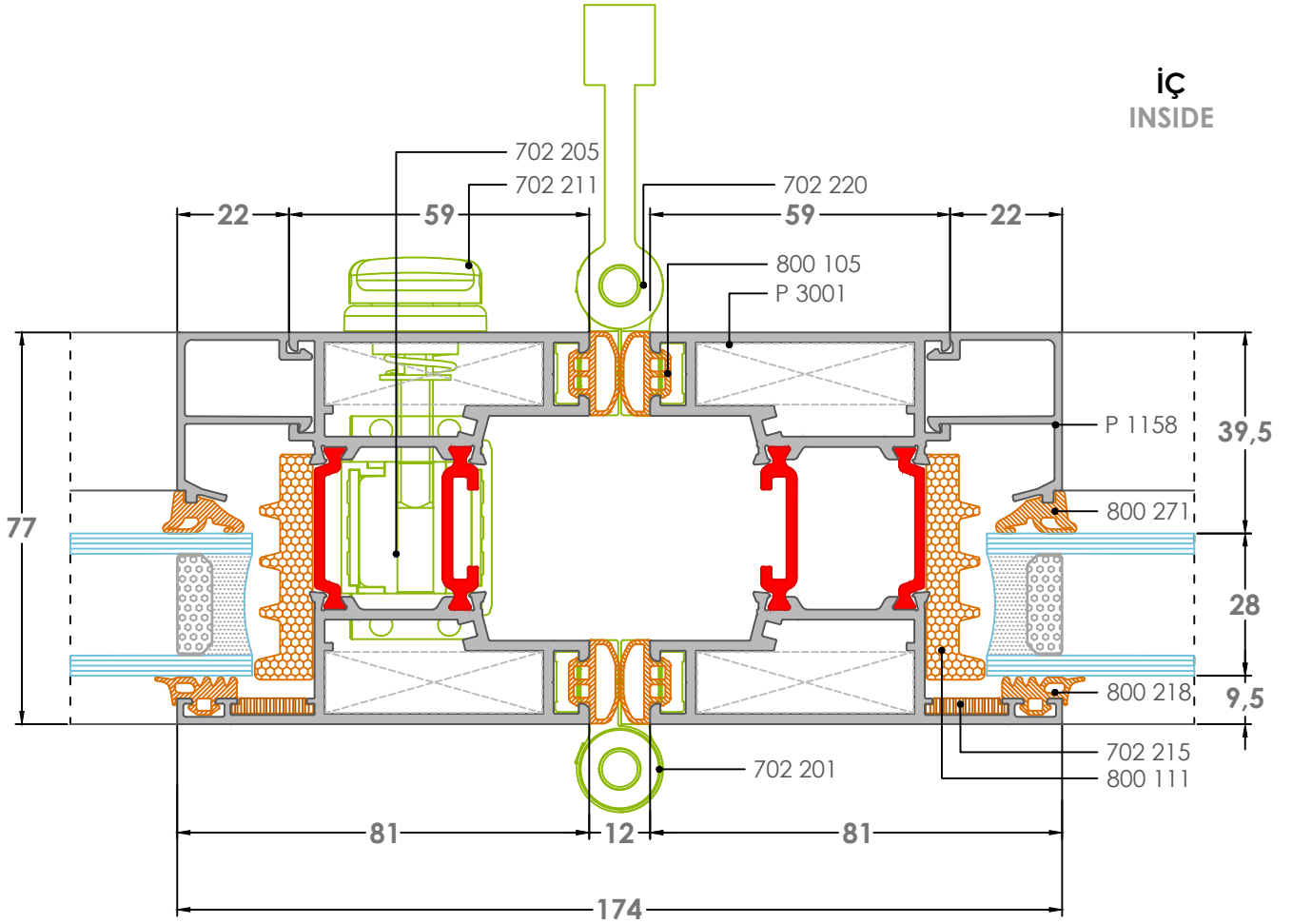
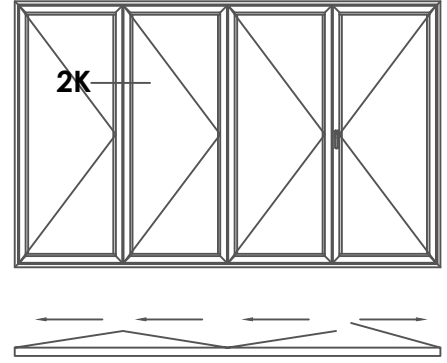

3K
Detay-Detail

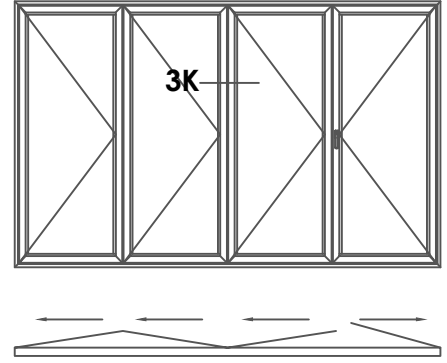

İÇ
INSIDE

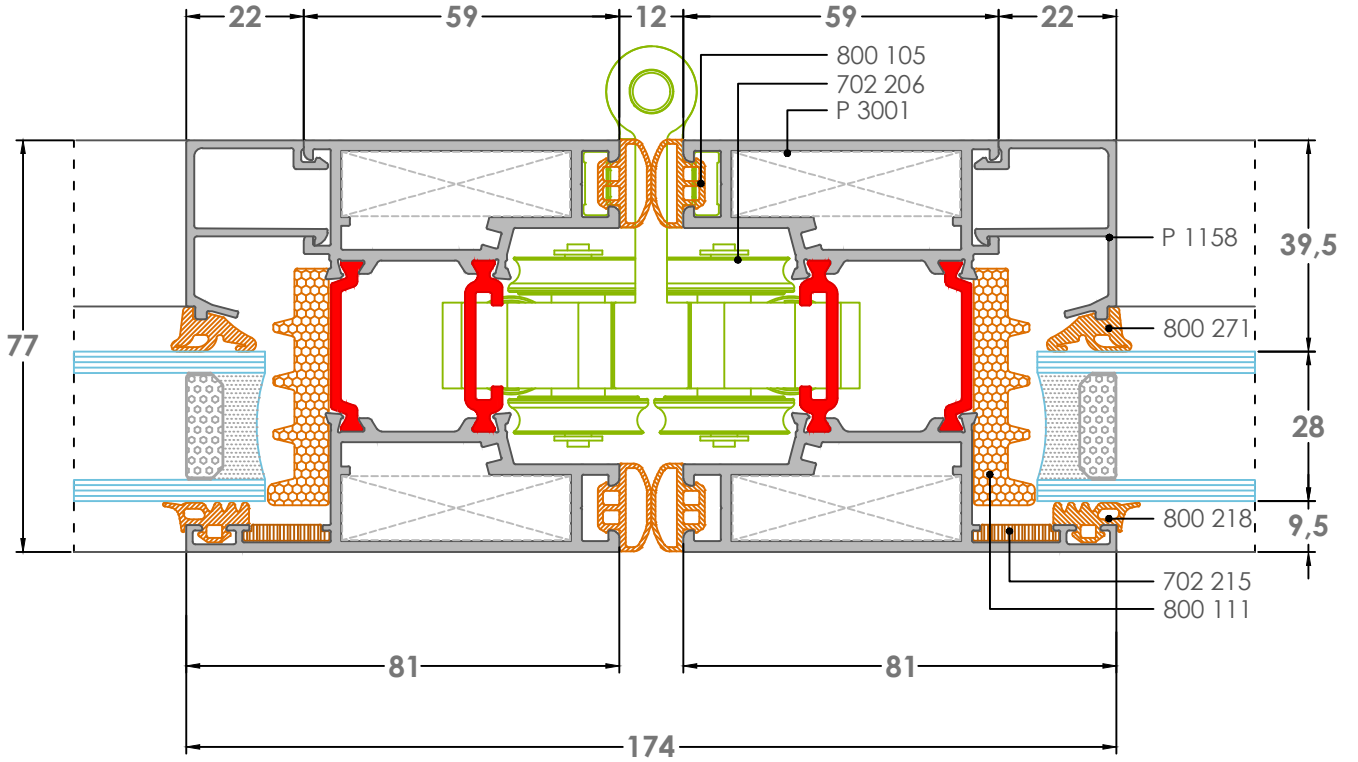

DIŞ
OUTSIDE

4K
Detay-Detail

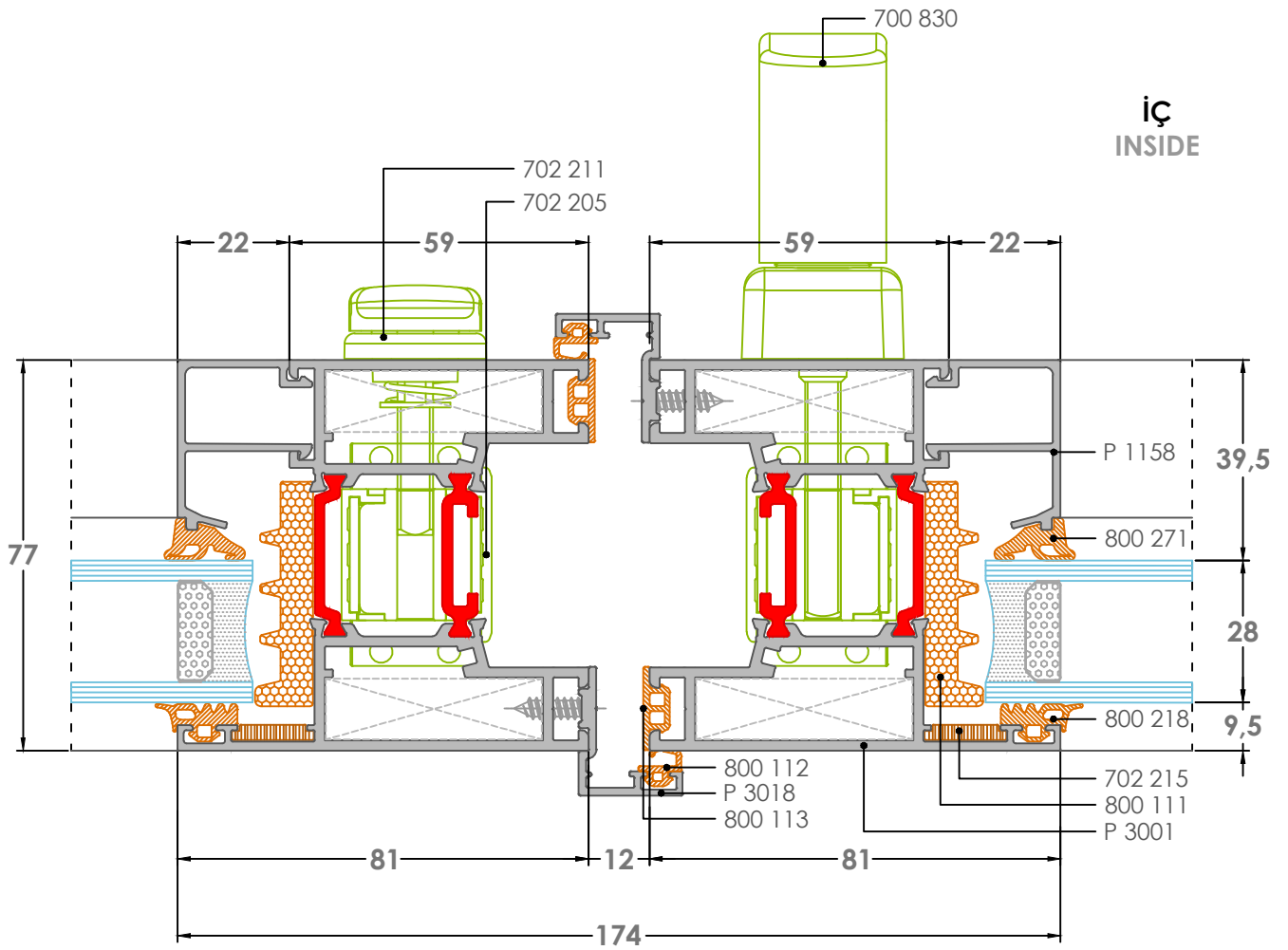
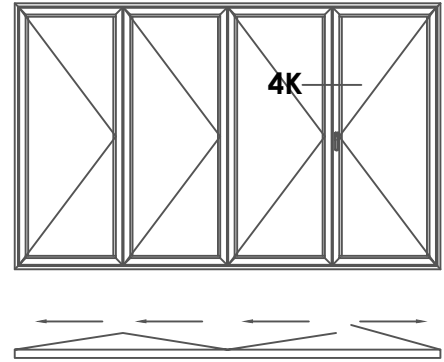

4K-1
Detay-Detail

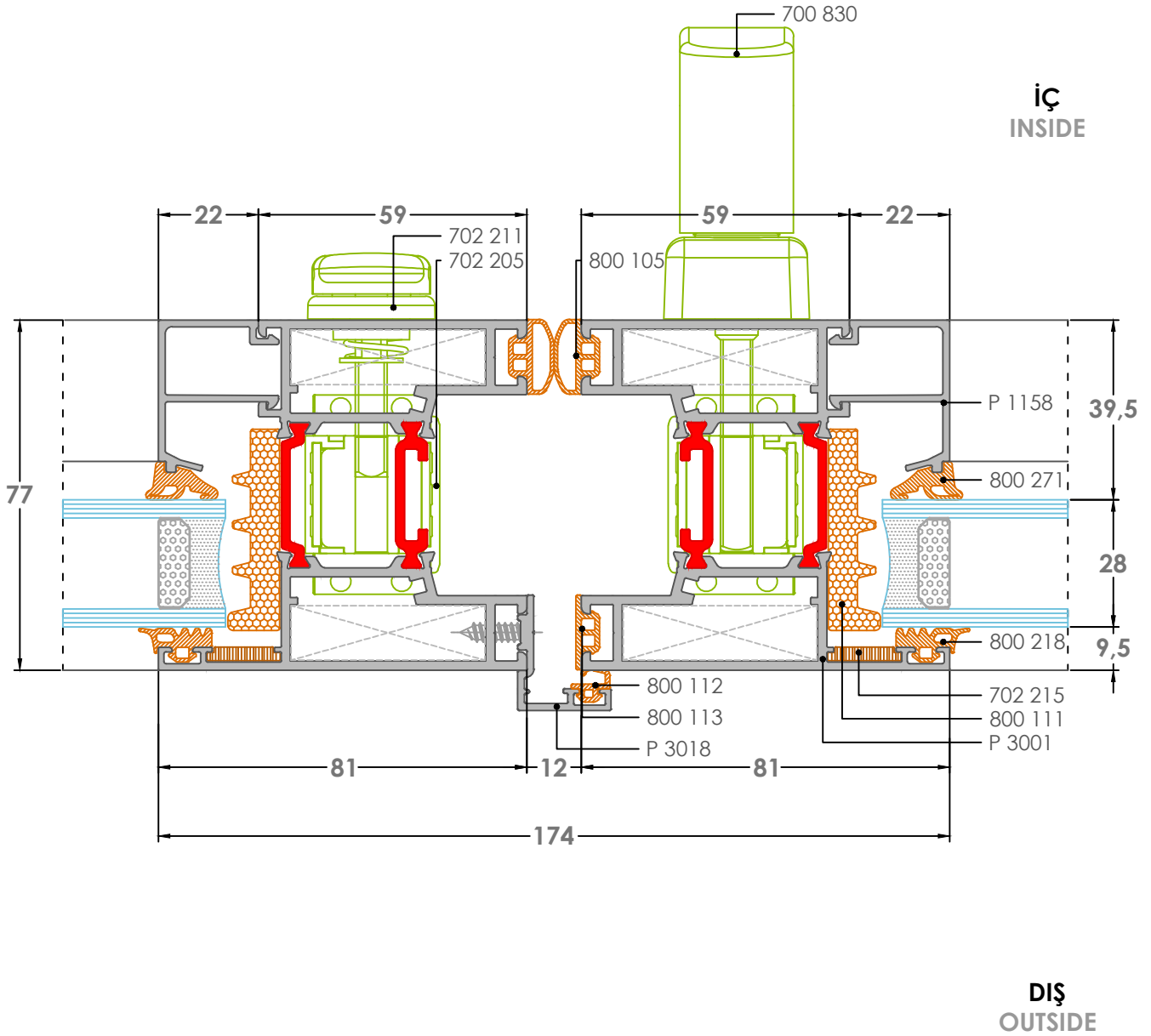
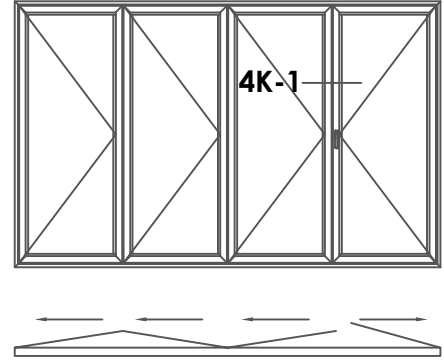

4K-2
Detay-Detail

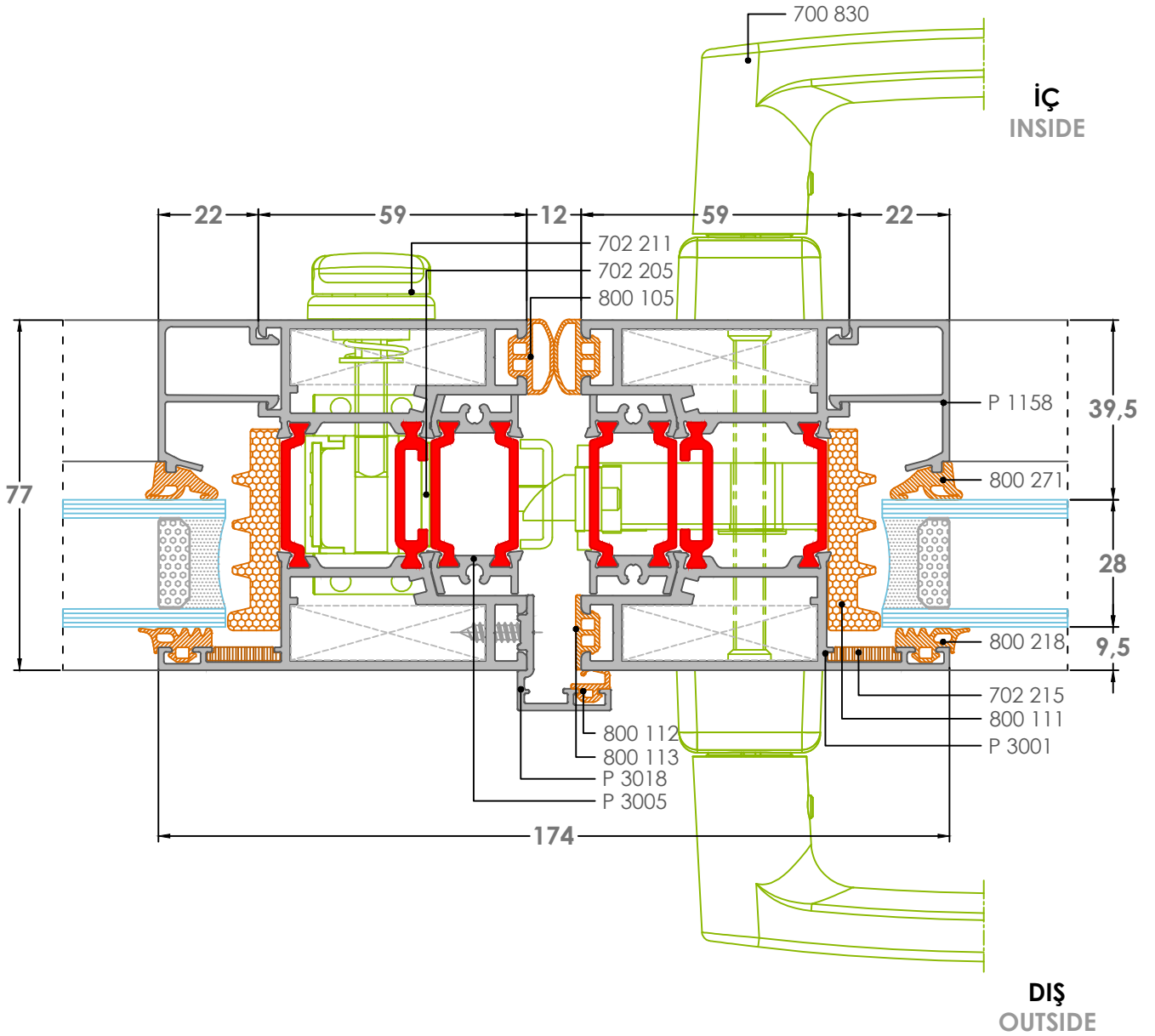
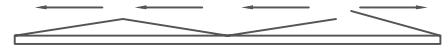
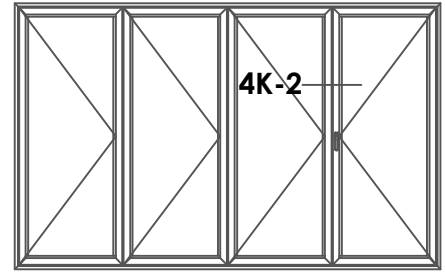

4K-3
Detay-Detail

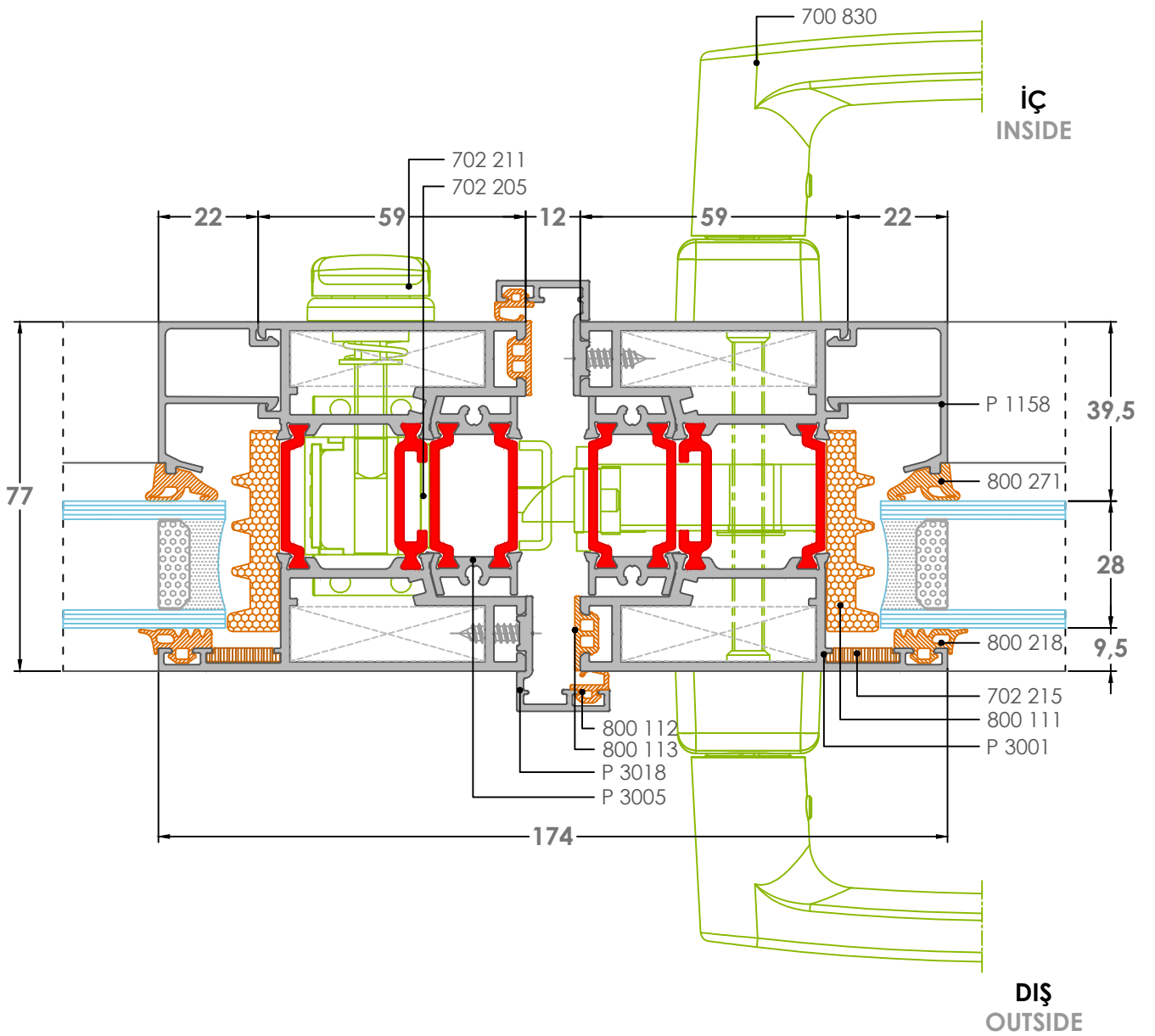
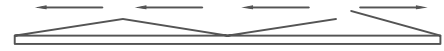
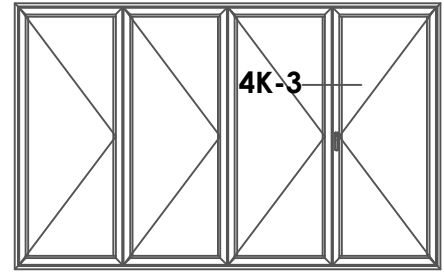

5K
Detay-Detail

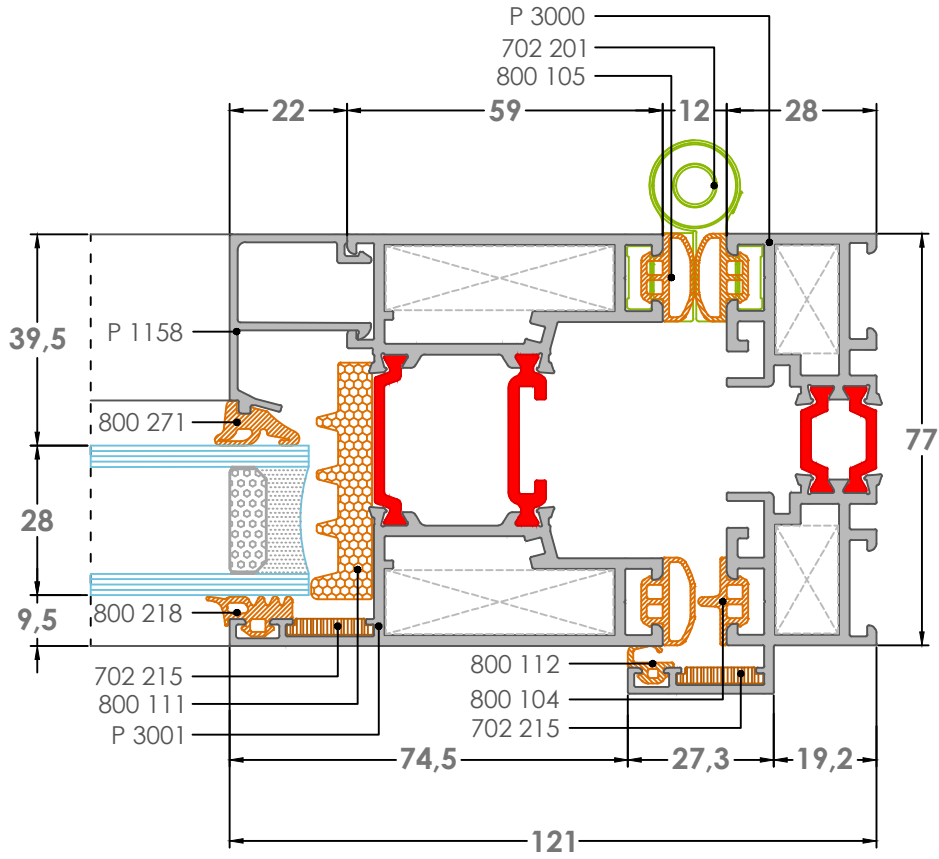
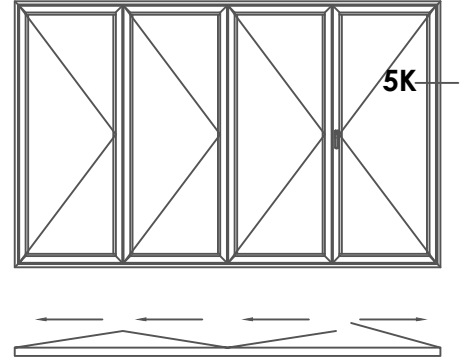

iç
INSIDE

DIŞ
OUTSIDE

5K-1
Detay-Detail

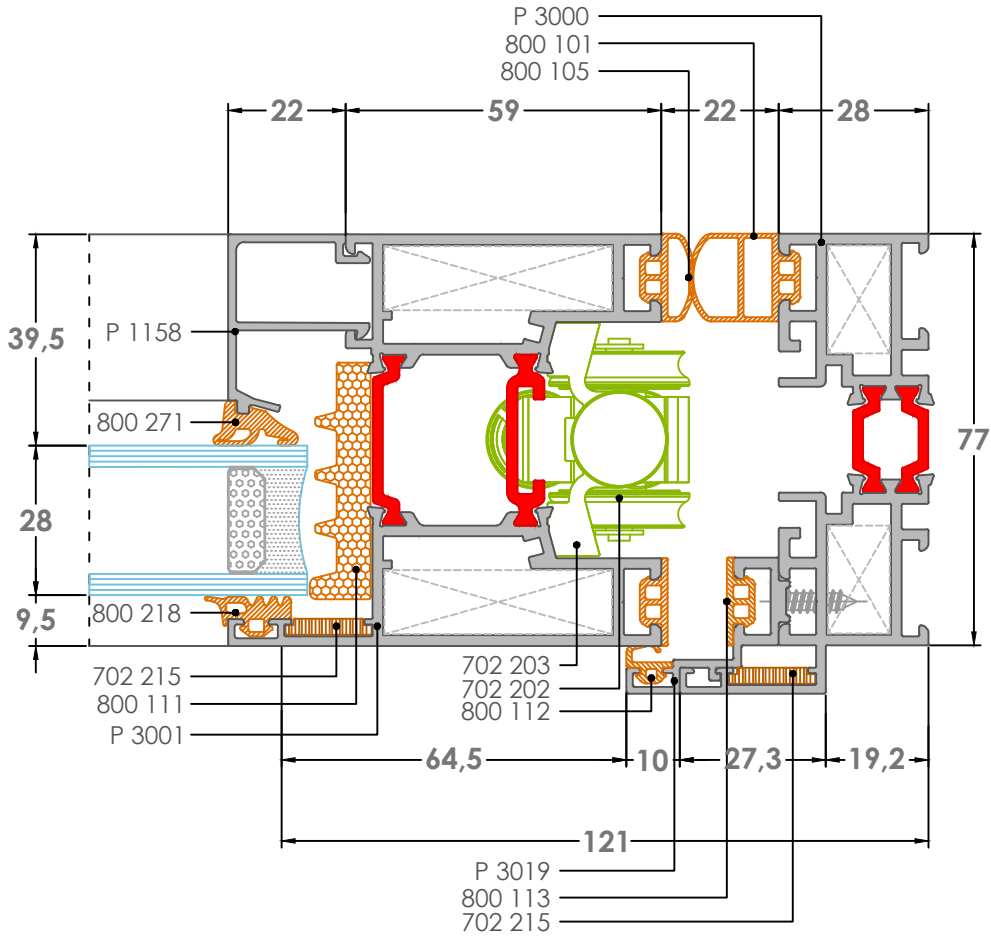
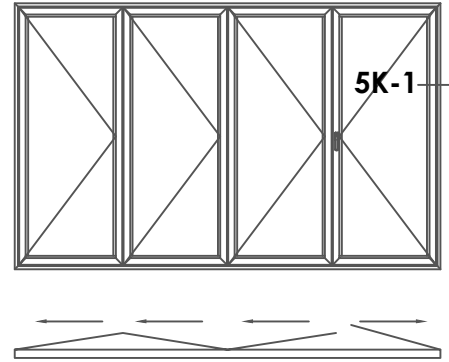

5K-2
Detay-Detail

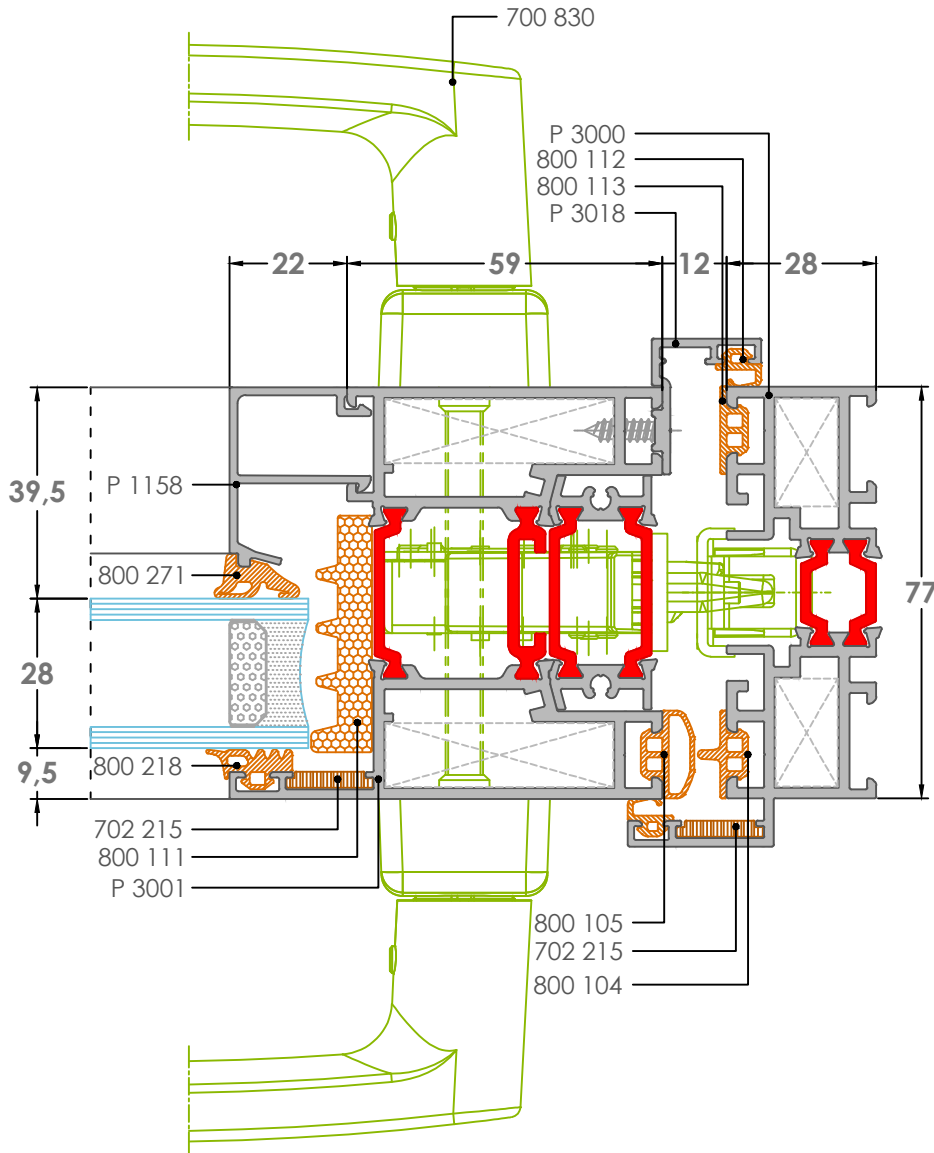
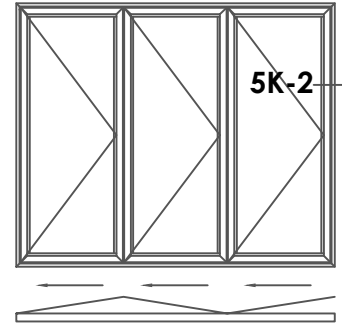

İÇ
INSIDE

DIŞ
OUTSIDE

5K-3
Detay-Detail

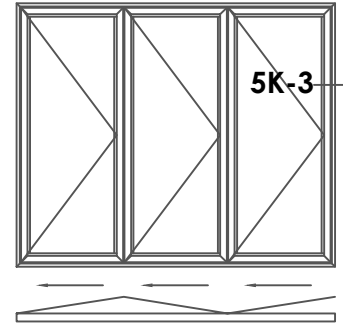

İÇ
INSIDE

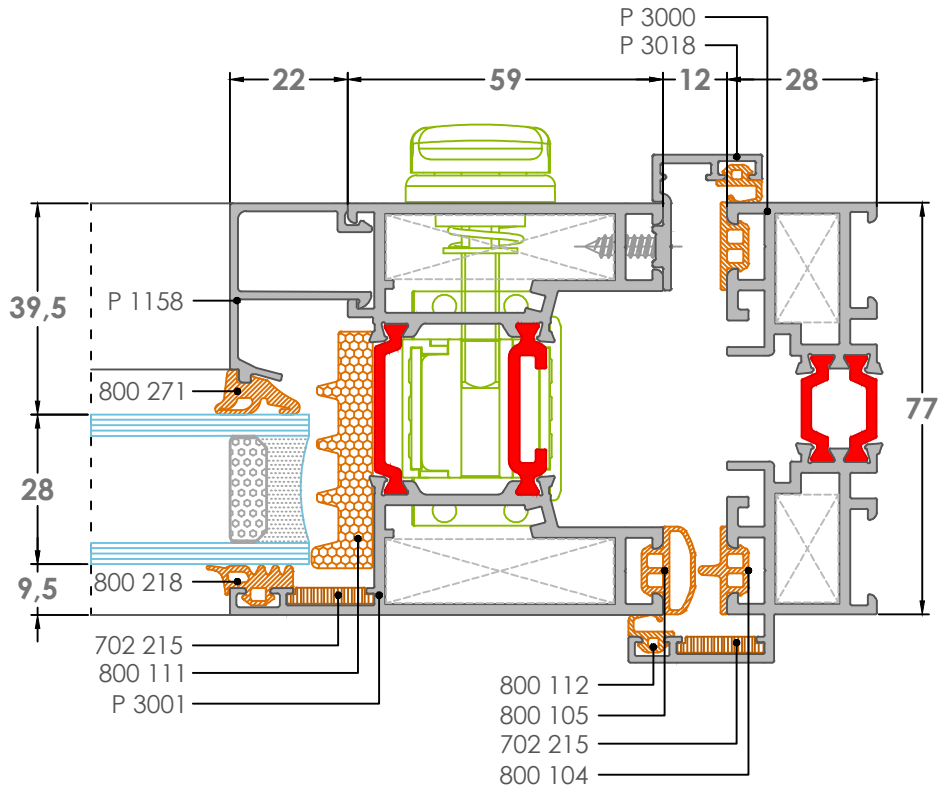

DIŞ
OUTSIDE

6K
Detay-Detail

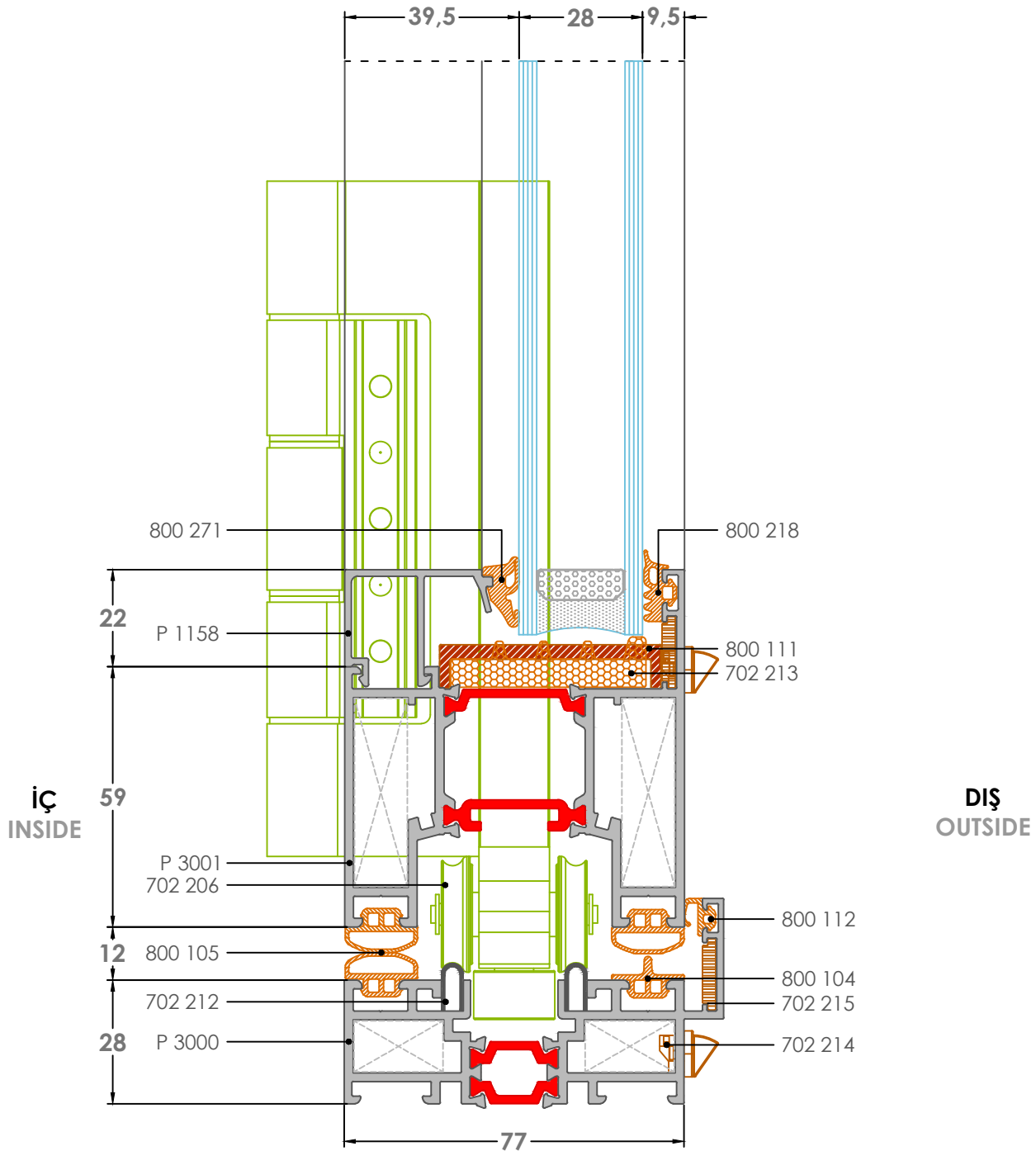
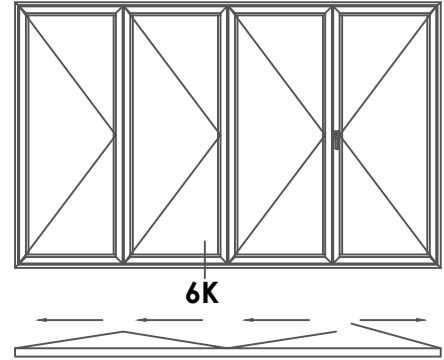

6K-1
Detay-Detail

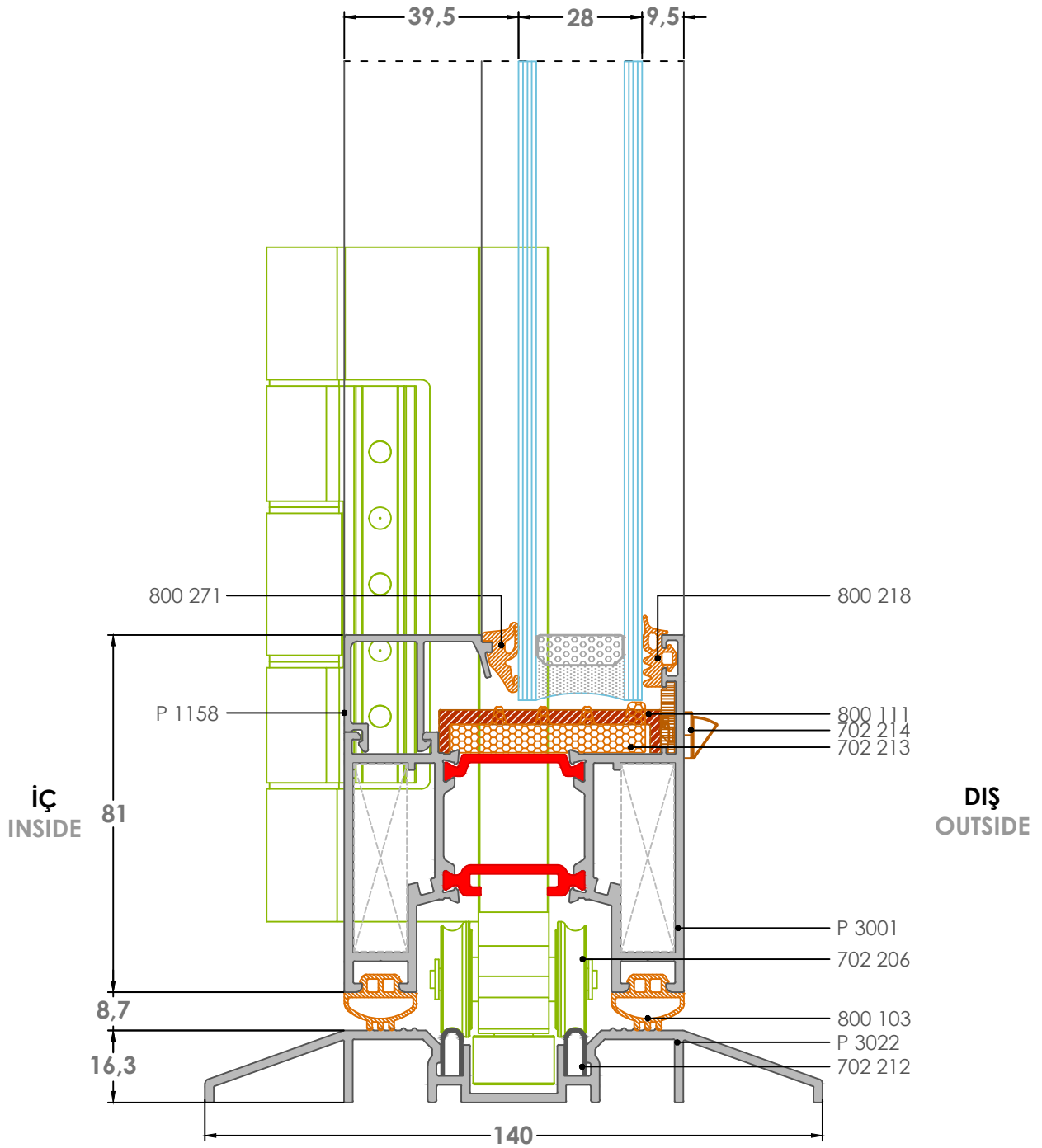
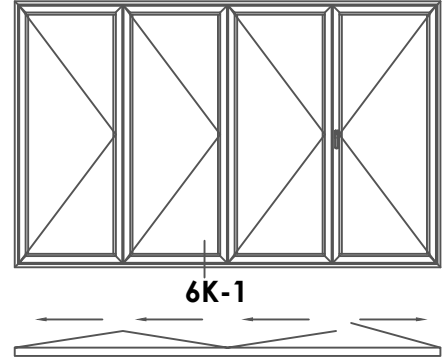

6K-2
Detay-Detail

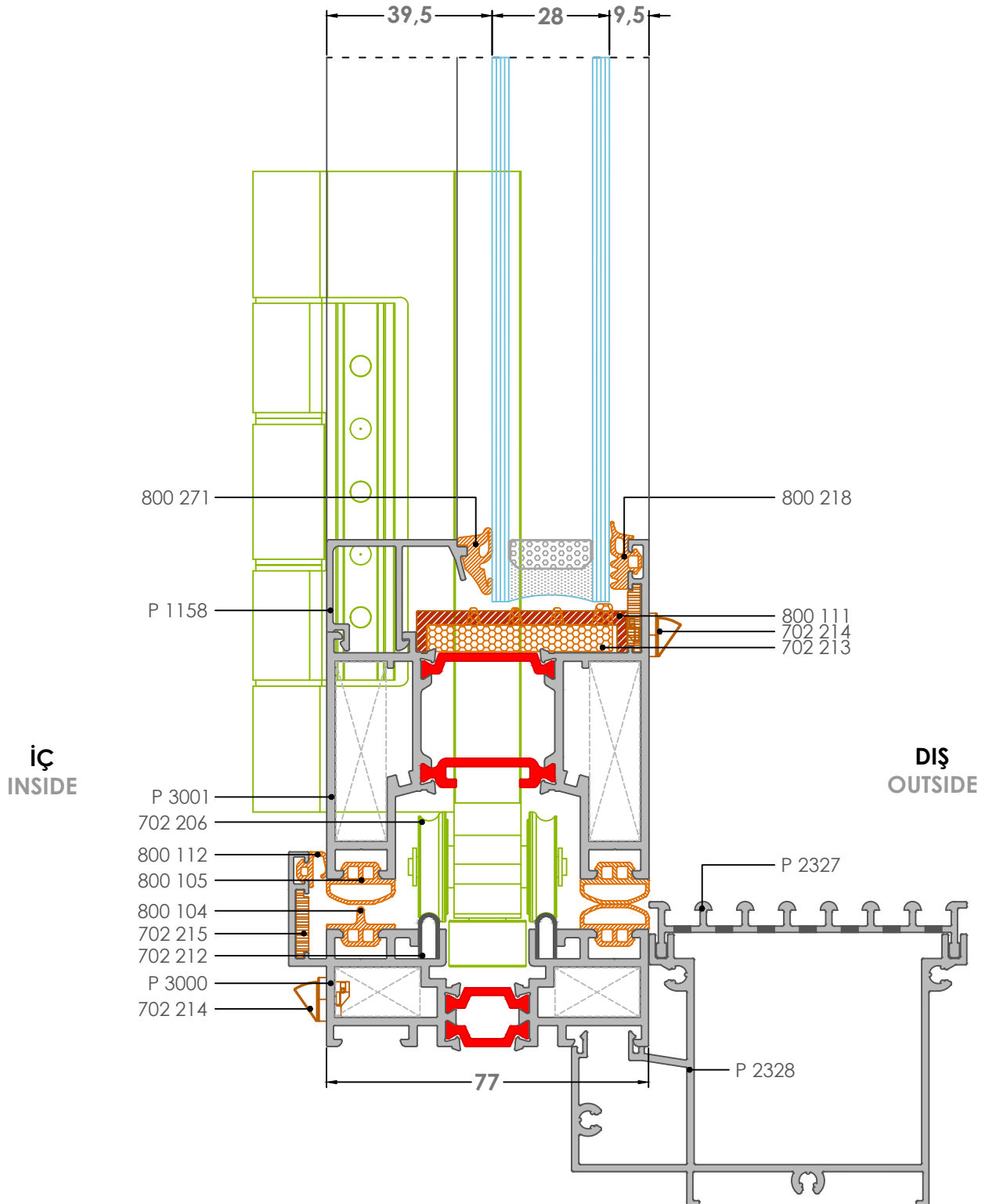
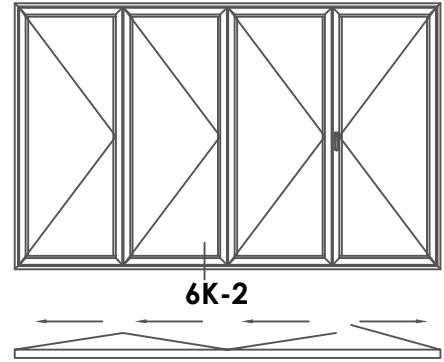

6K-3
Detay-Detail

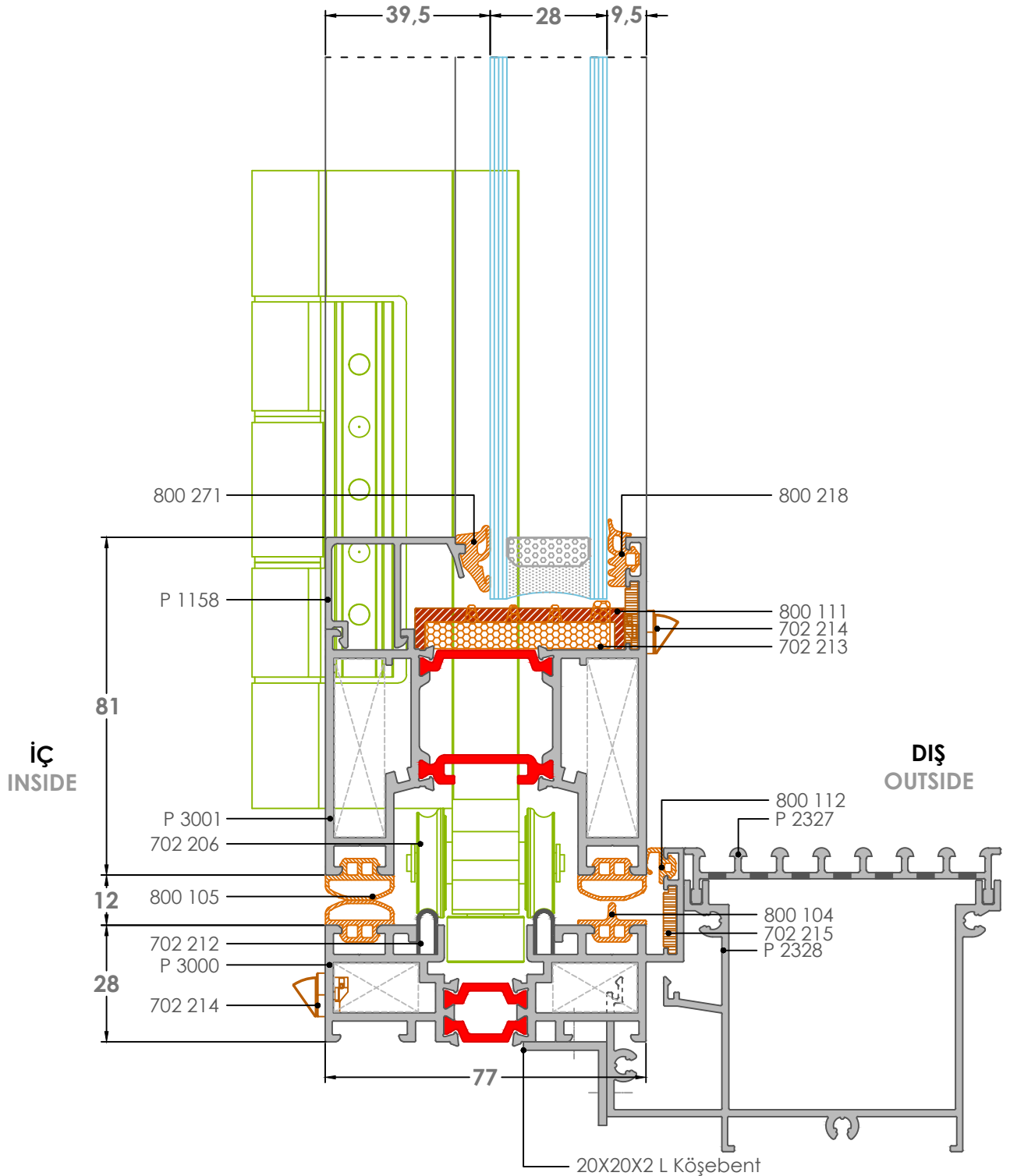
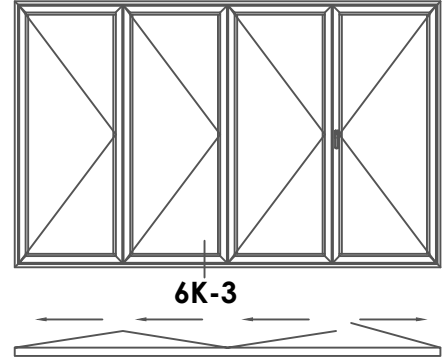

7K
Detay-Detail

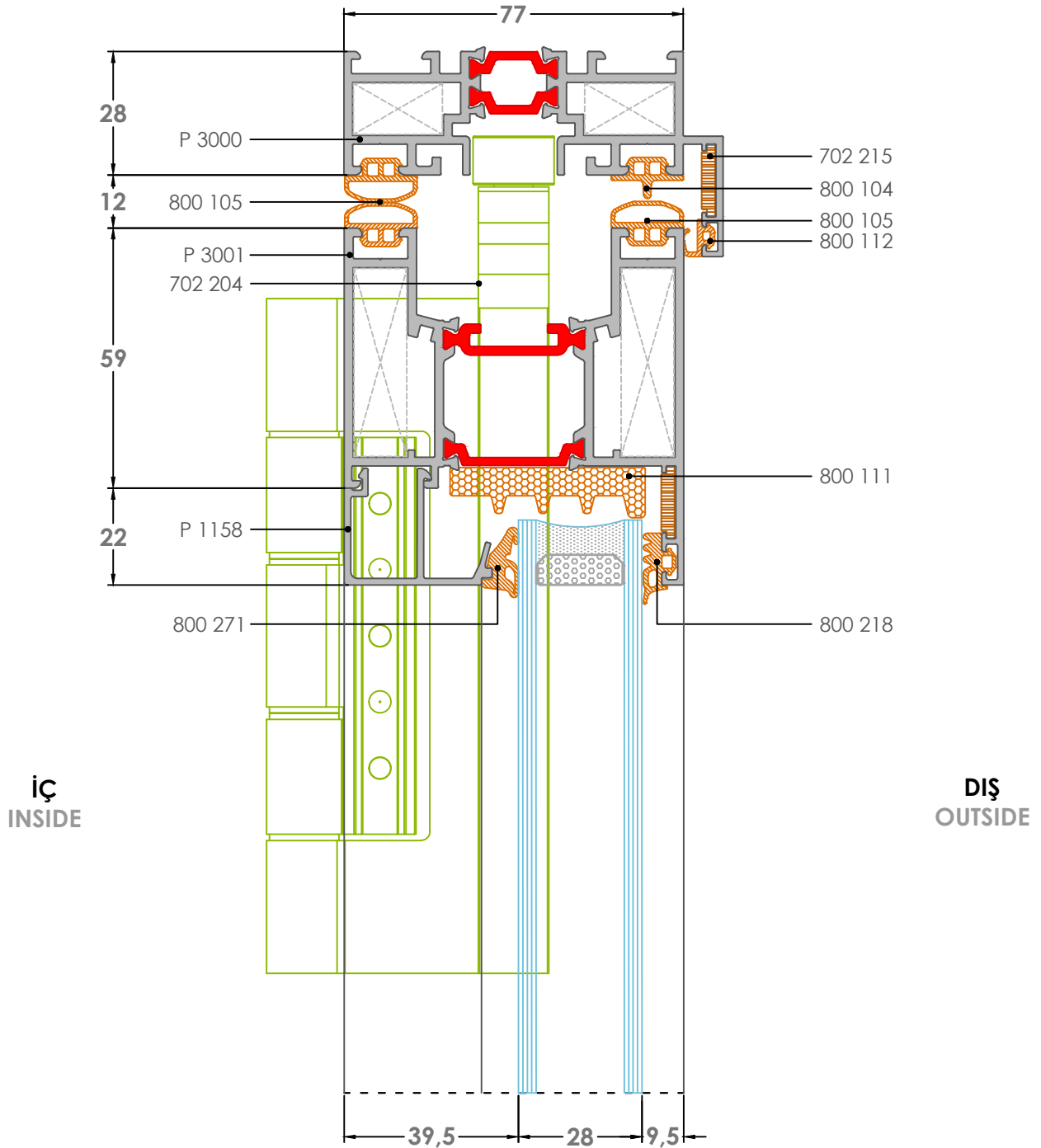
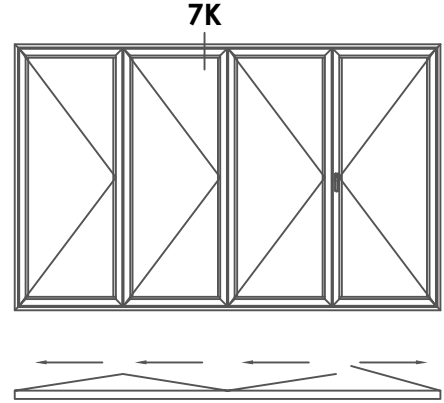

8K
Detay-Detail

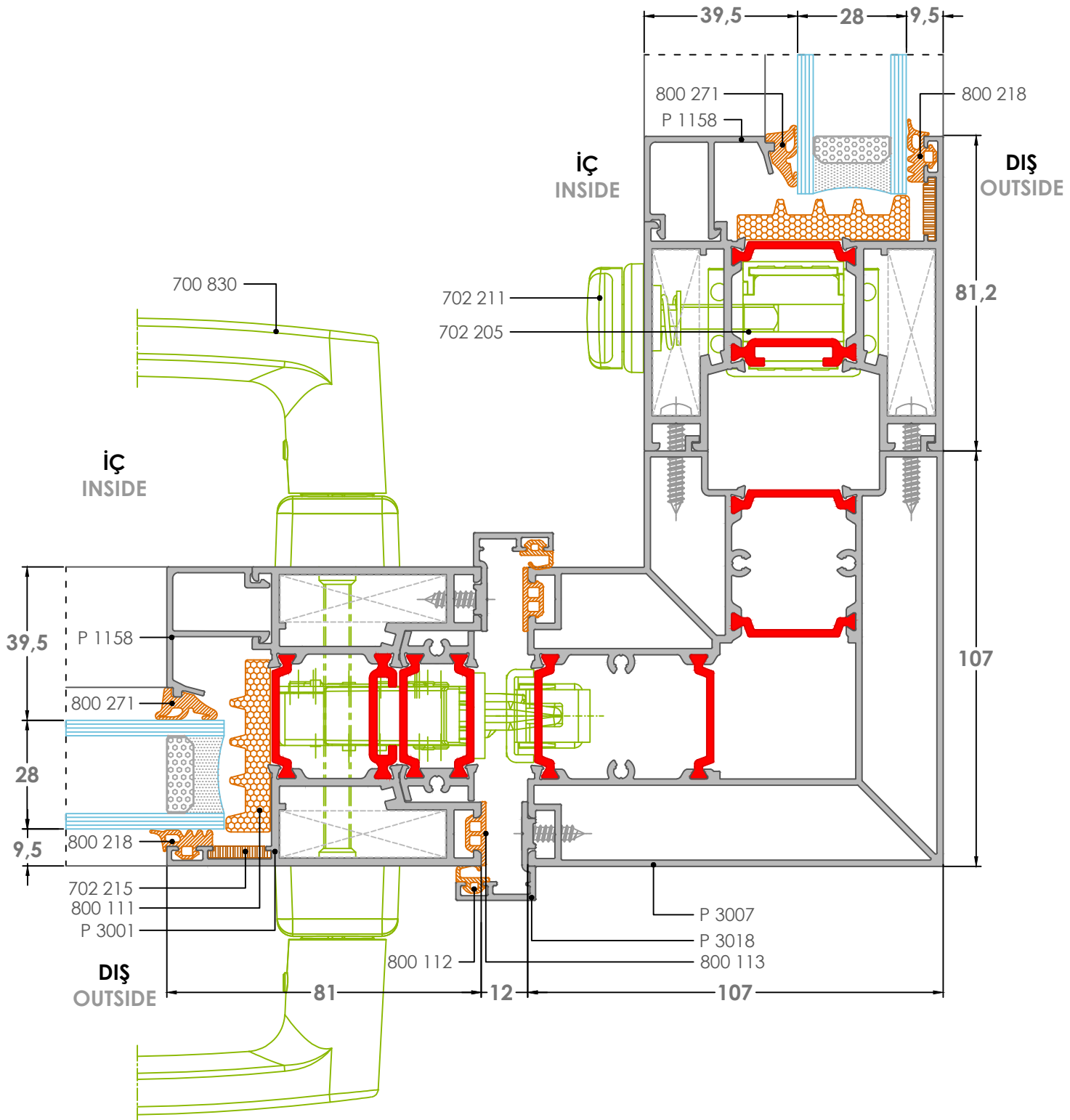
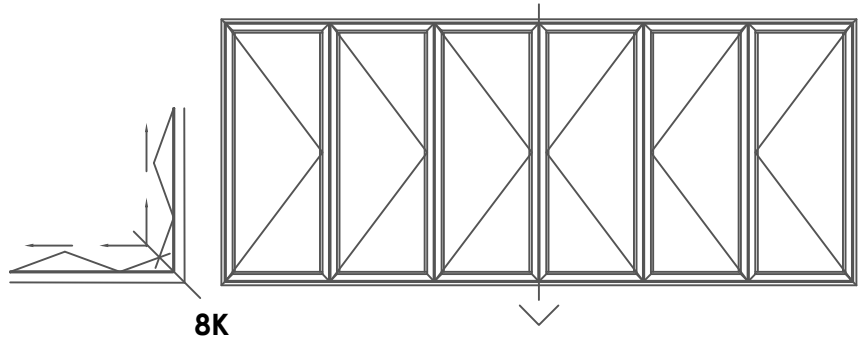

9K
Detay-Detail

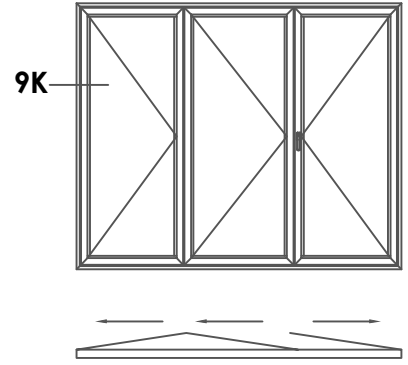

İÇ
INSIDE

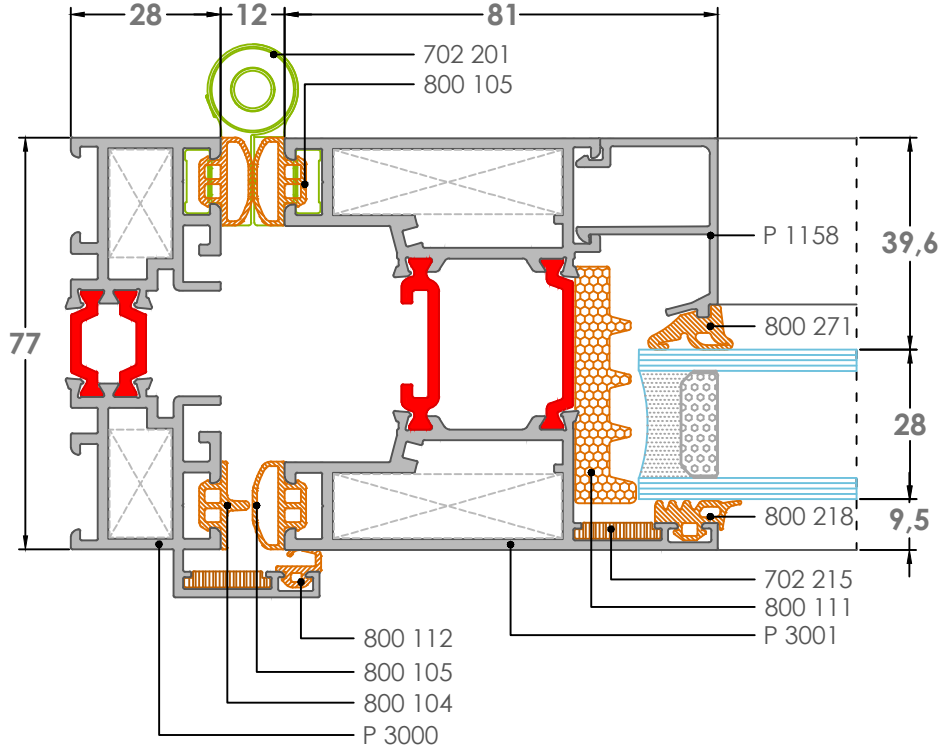

DIŞ
OUTSIDE

10K
Detay-Detail

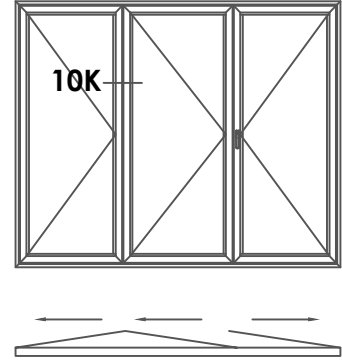

İÇ
INSIDE

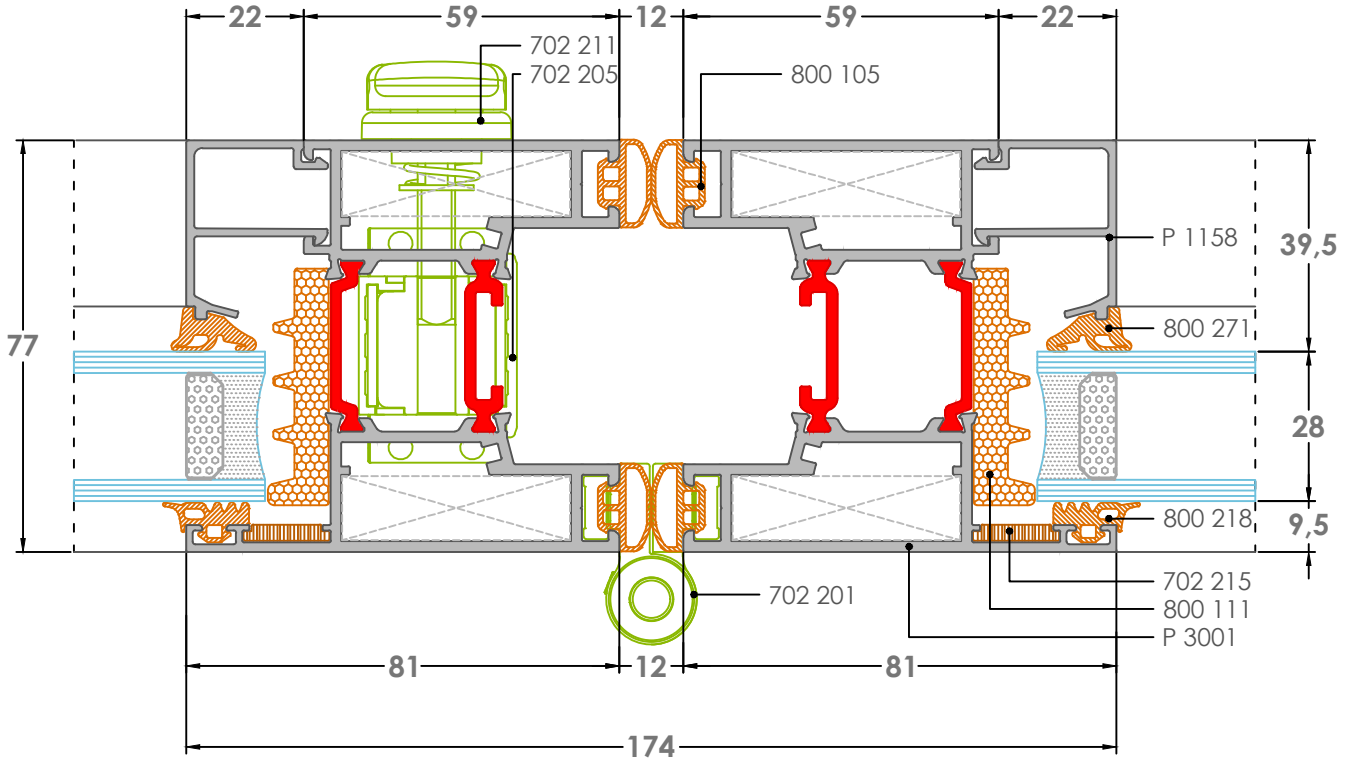

DIŞ
OUTSIDE

11K
Detay-Detail

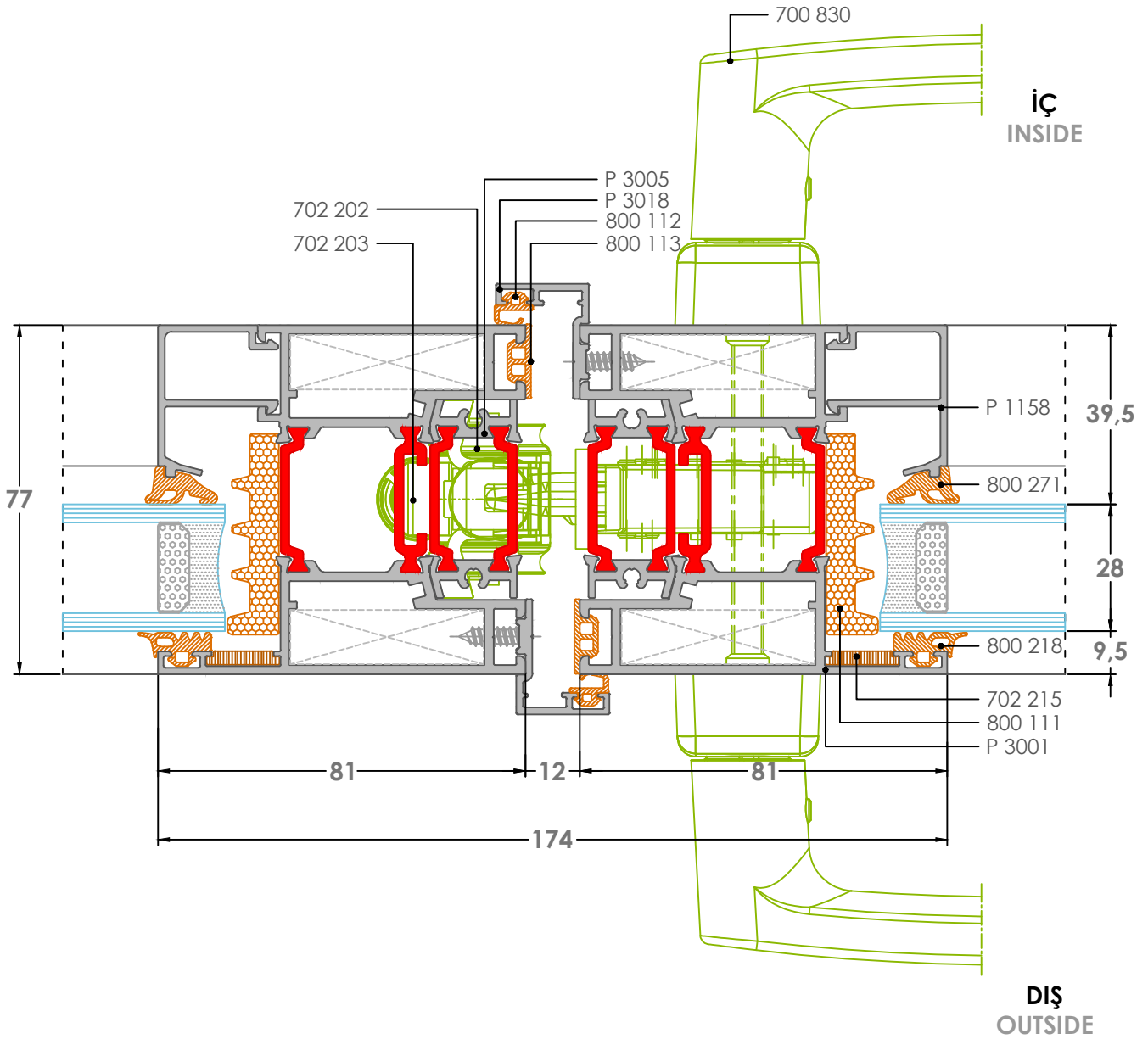
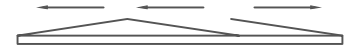
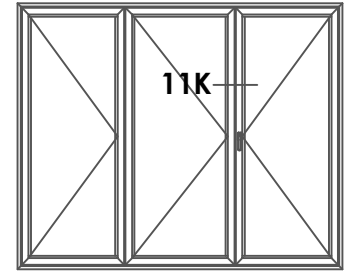

12K
Detay-Detail

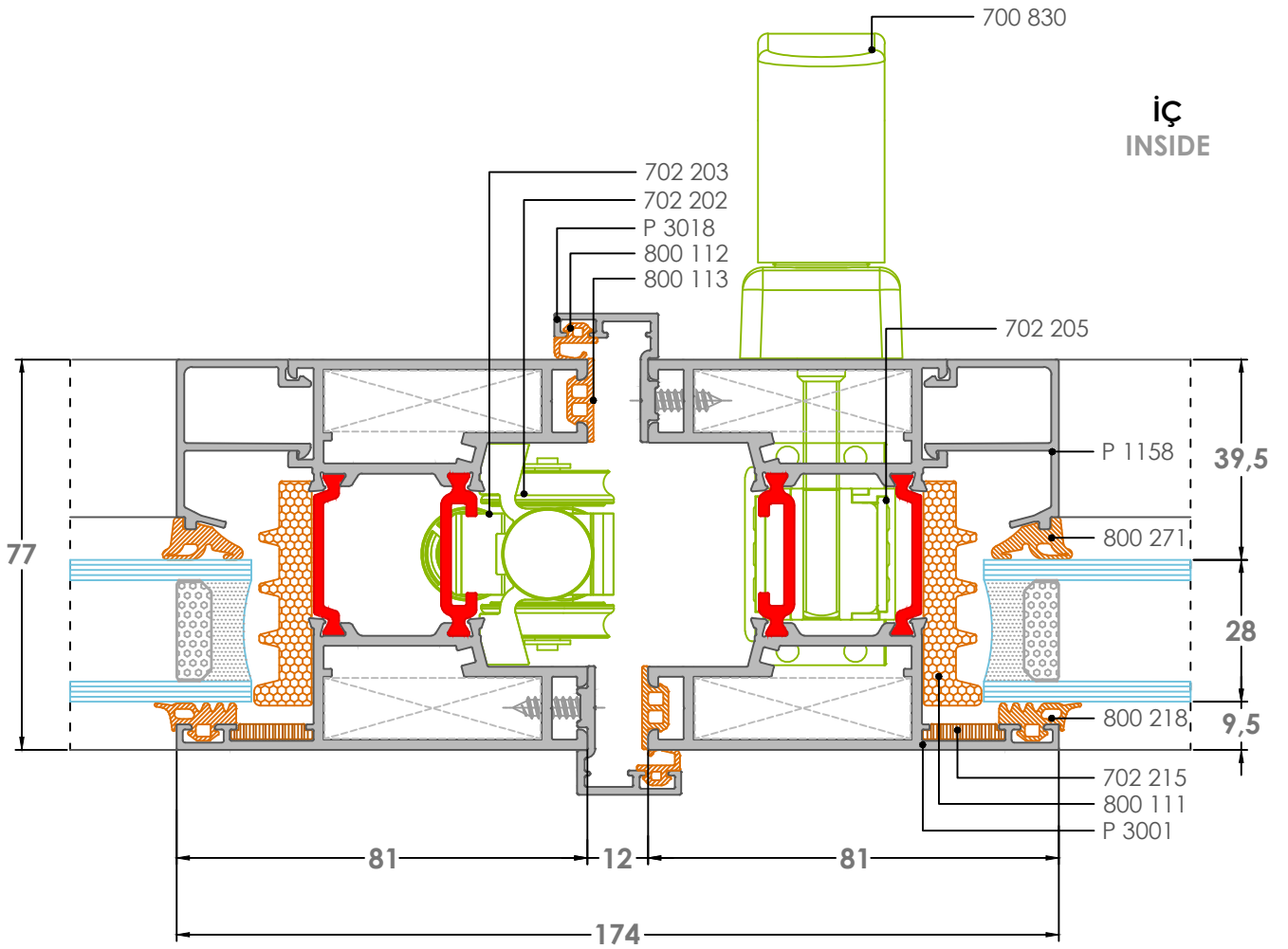
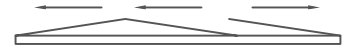
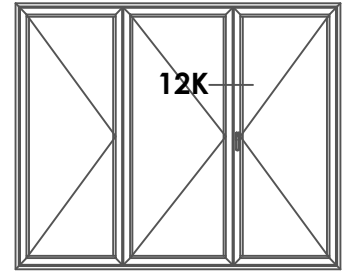

13K
Detay-Detail

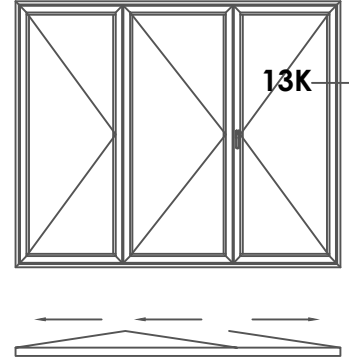

İÇ
INSIDE

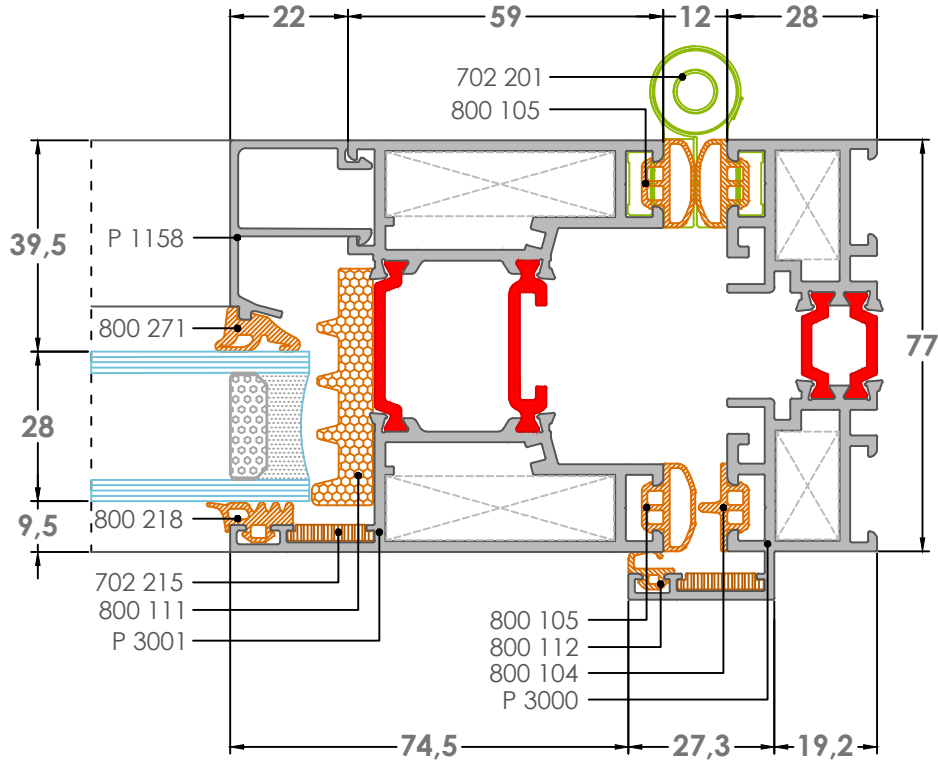

DIŞ
OUTSIDE

14K
Detay-Detail

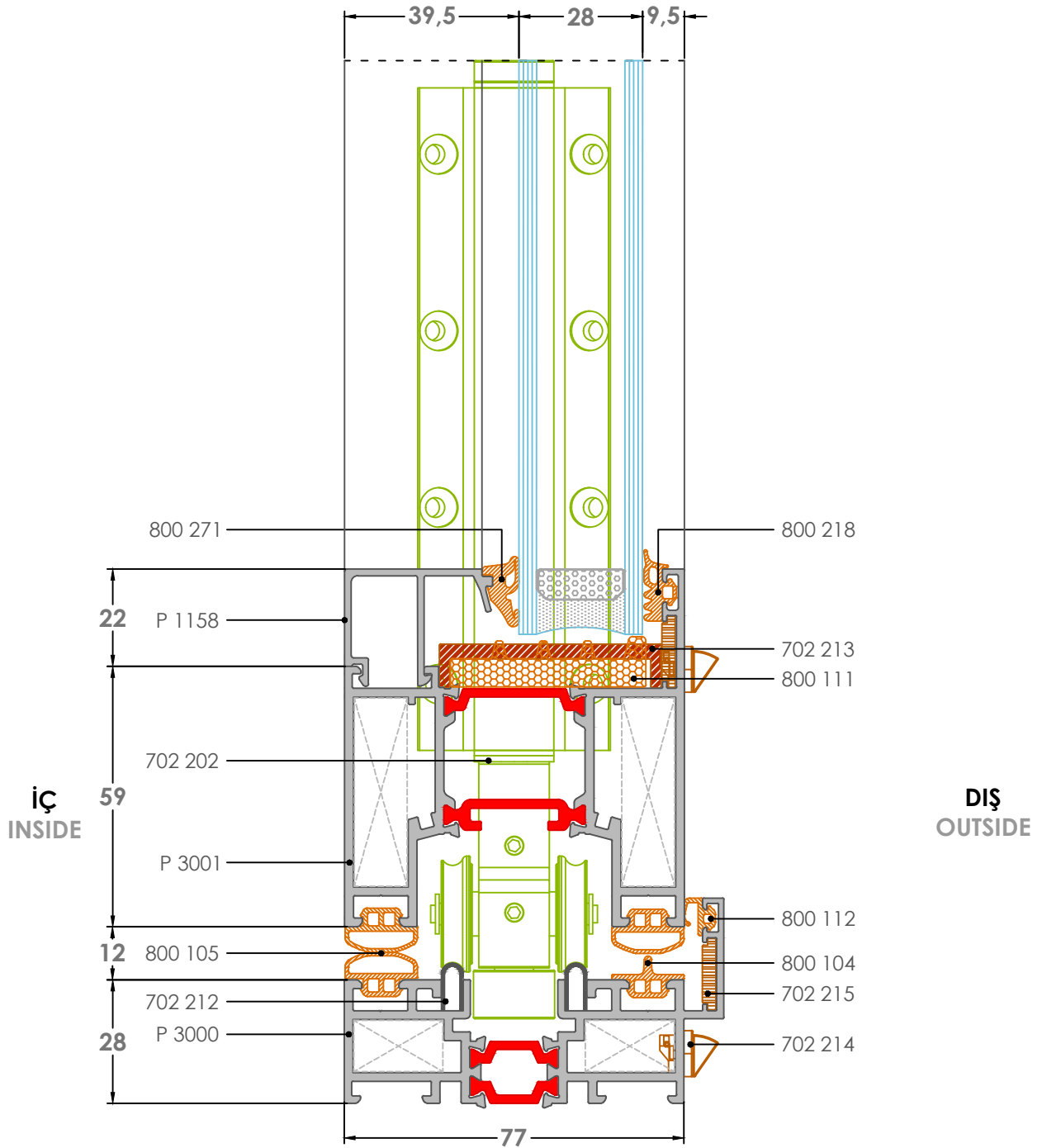
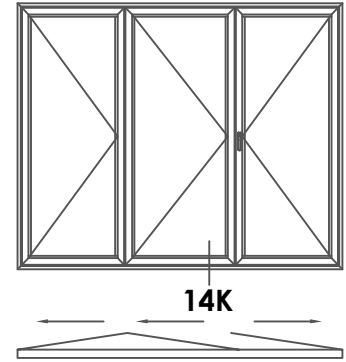

14K-1
Detay-Detail

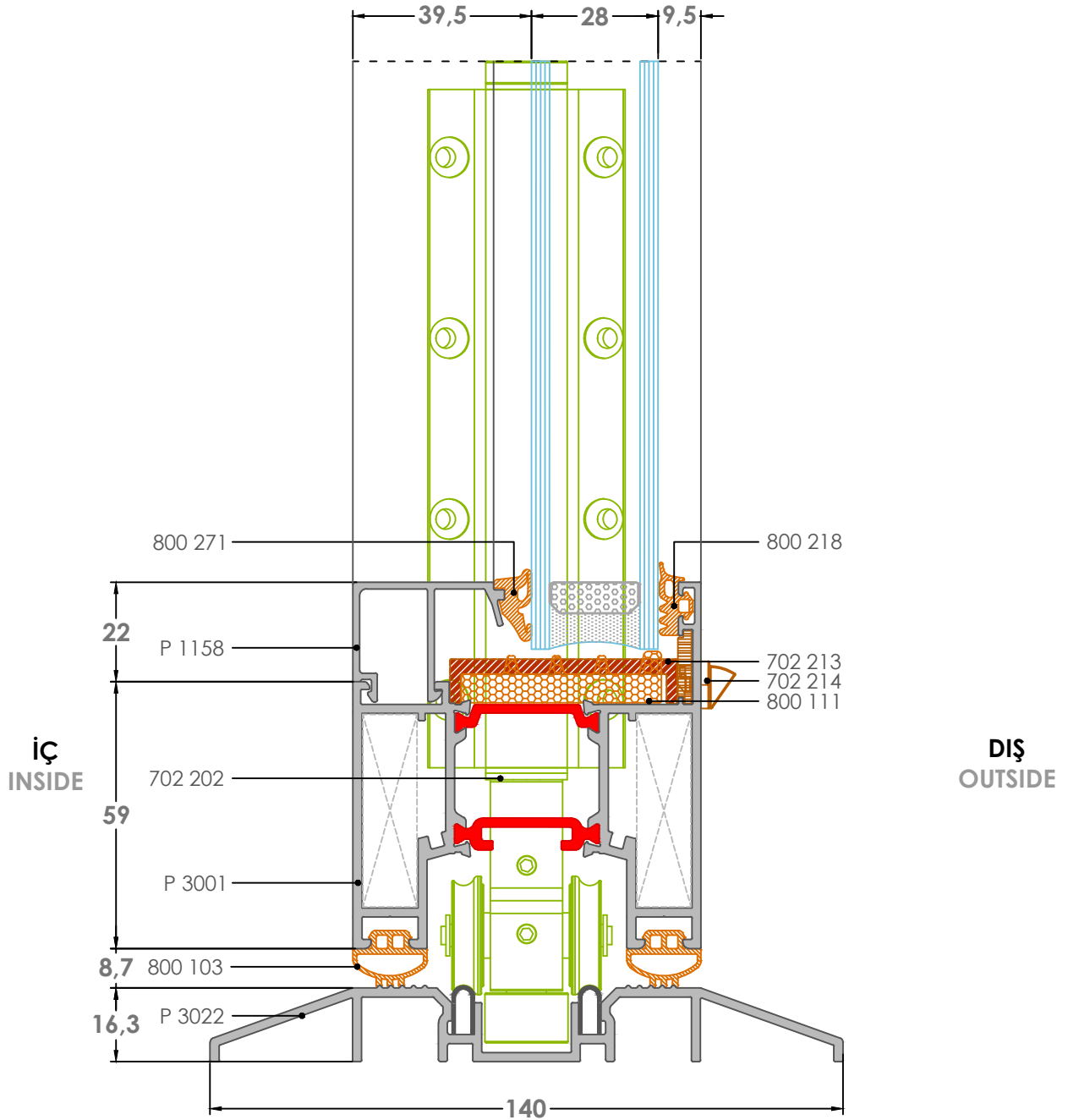
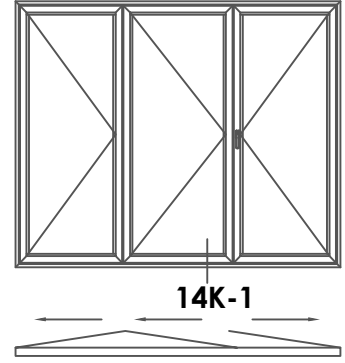

15K
Detay-Detail

15K

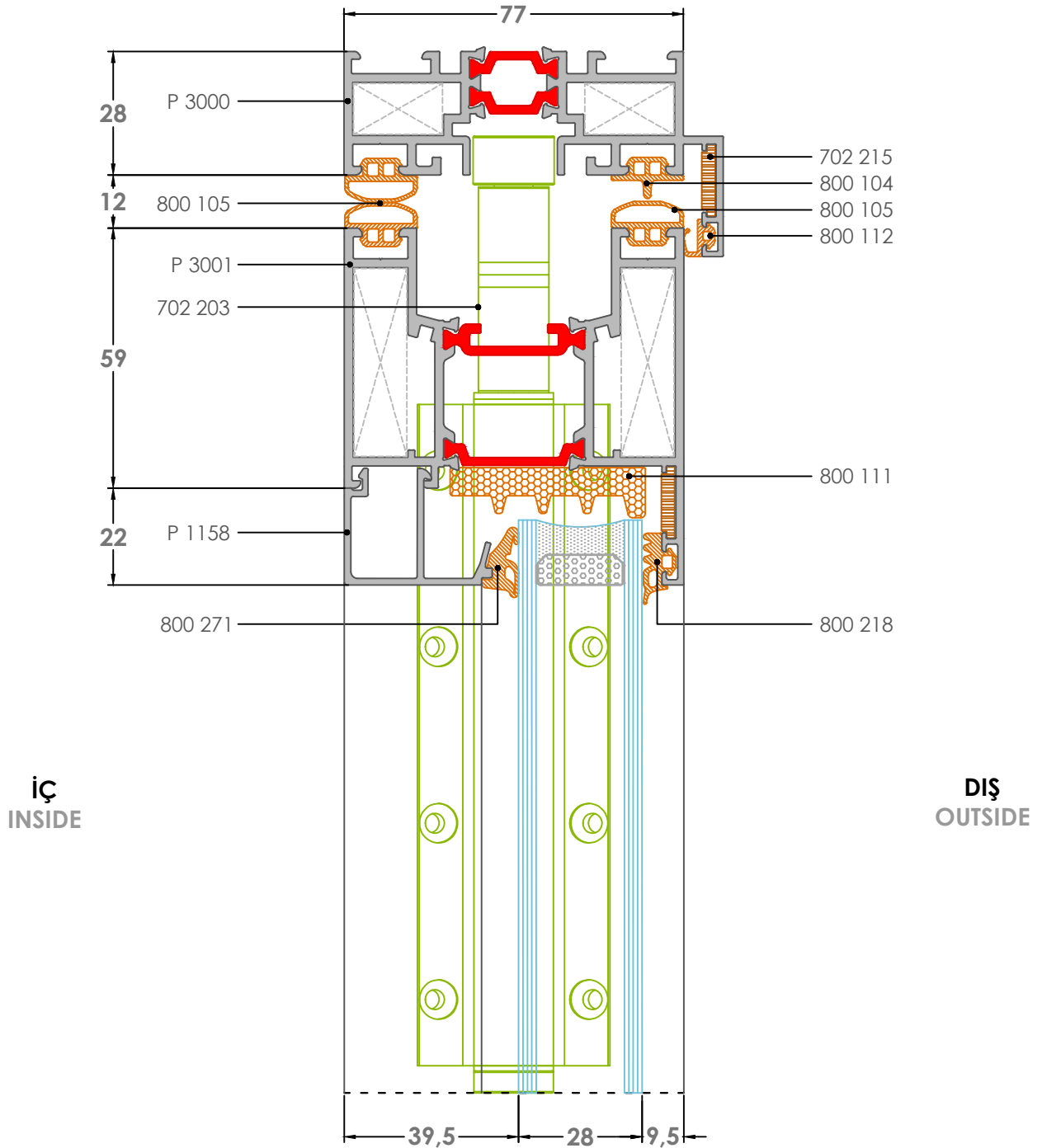
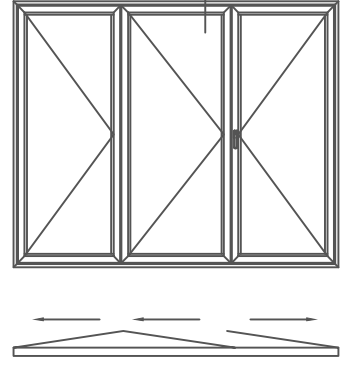

1K-1
Detay-Detail

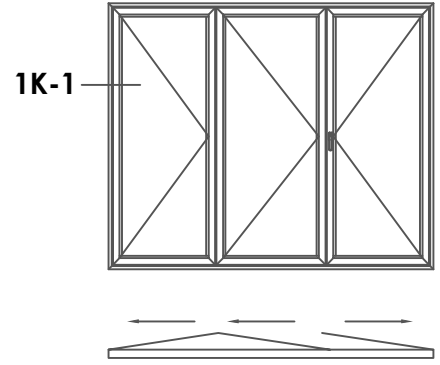

İÇ
INSIDE

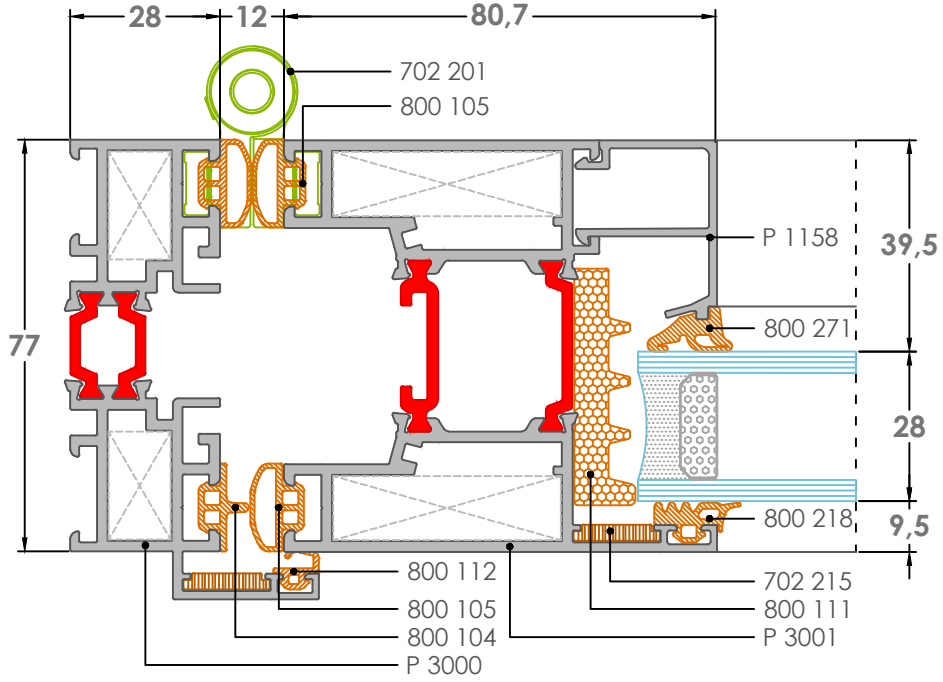

DIŞ
OUTSIDE

2K-1
Detay-Detail

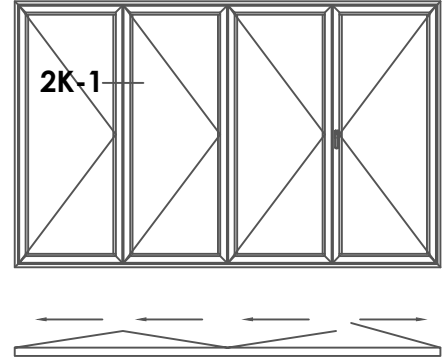

İÇ
INSIDE

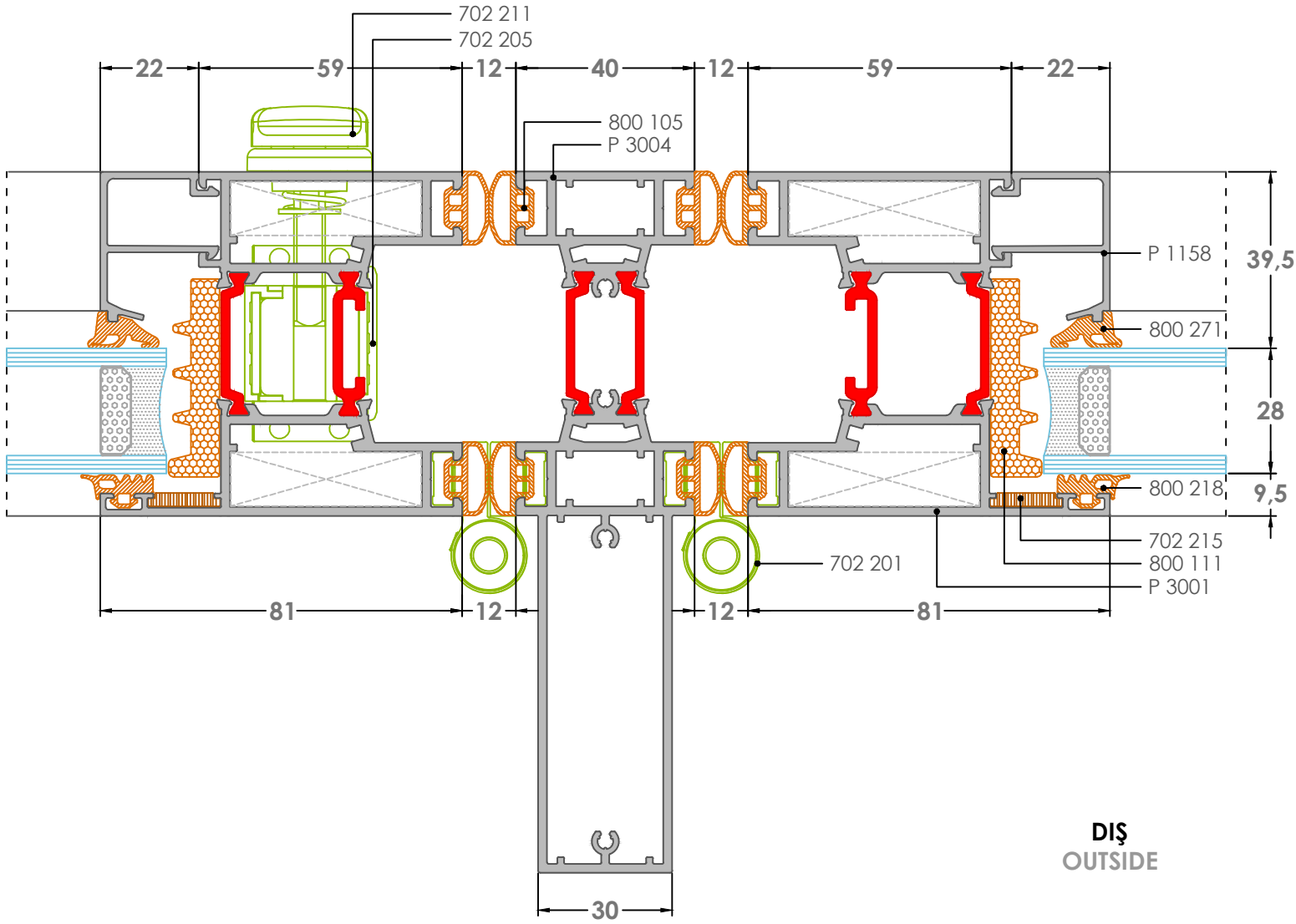

3K-1
Detay-Detail

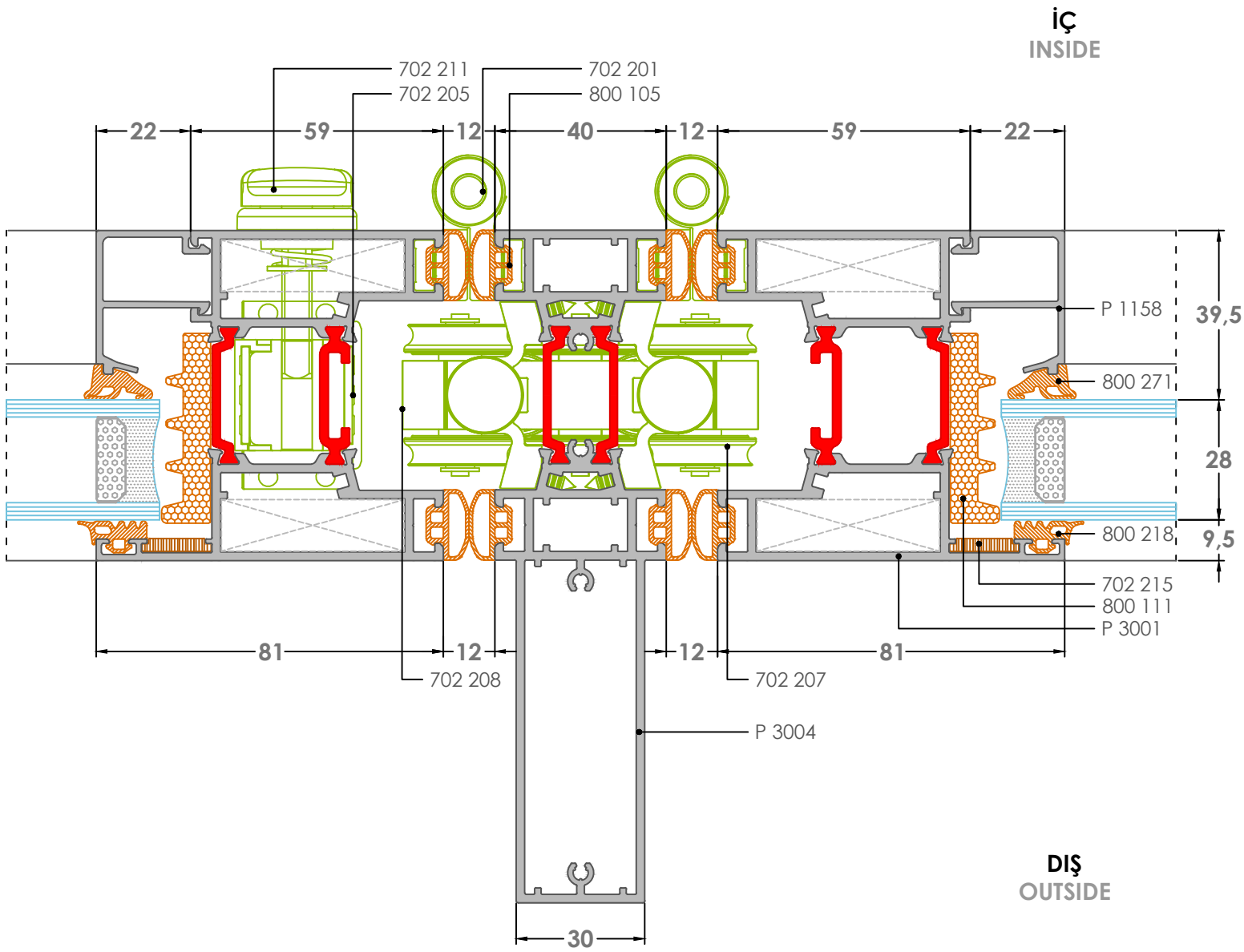
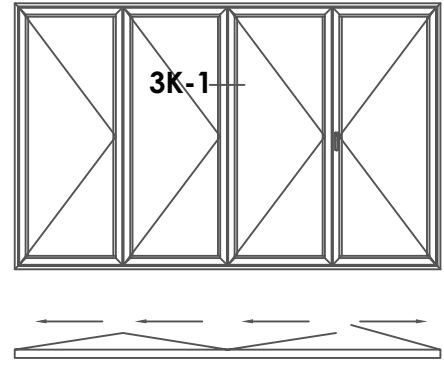

4K-4
Detay-Detail

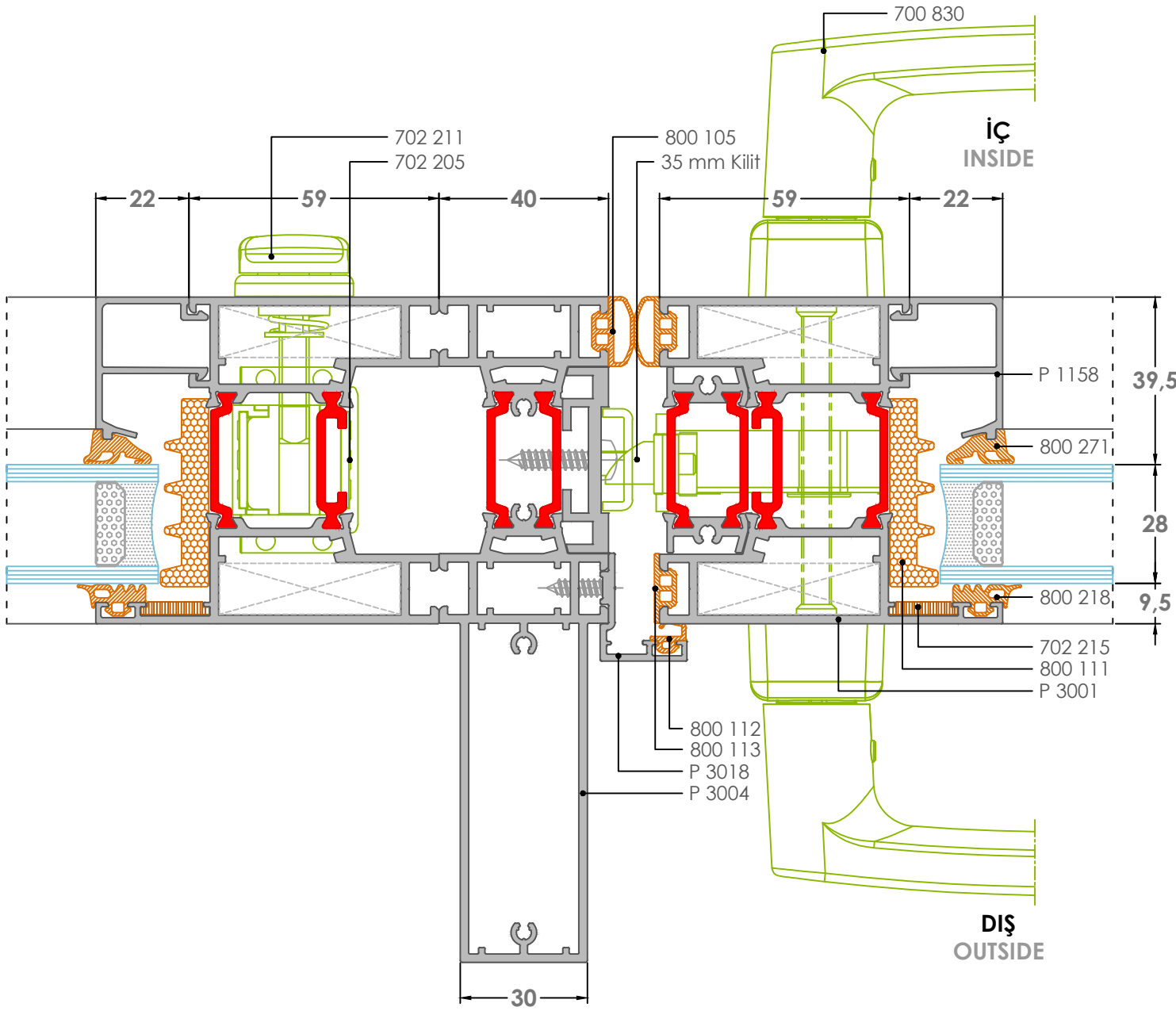
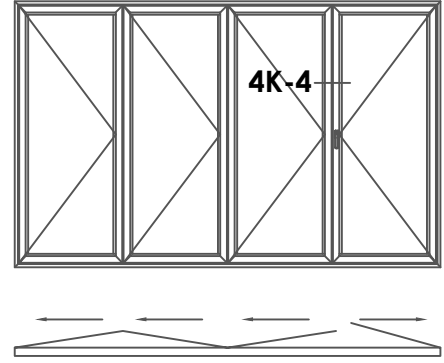

4K-5
Detay-Detail

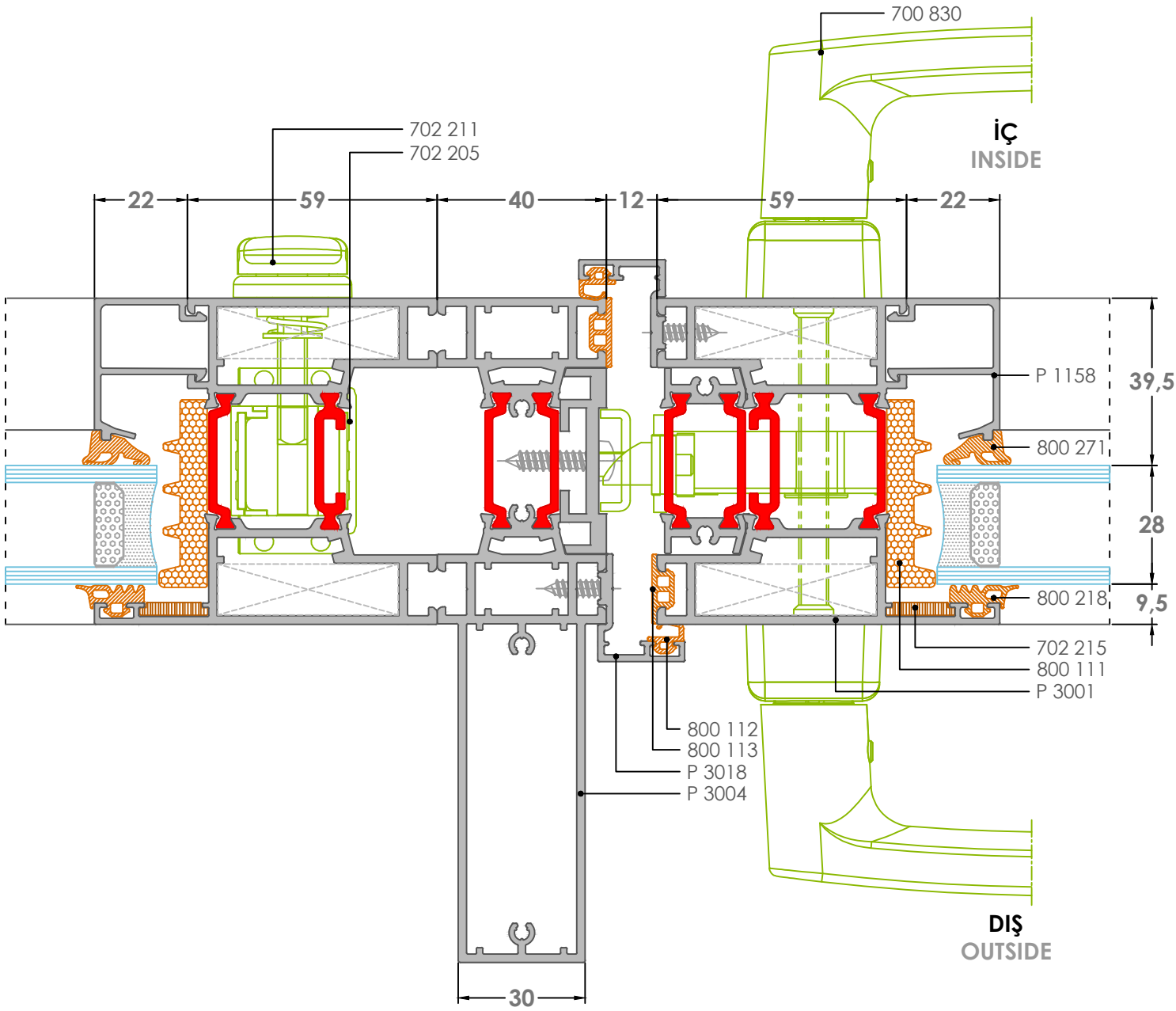
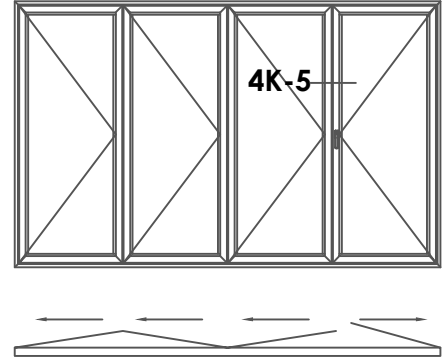

**PANORAMA KATLANIR KAPI
İMALAT KESİM ÖLÇÜLERİ
PANORAMA FOLDING DOOR
FABRICATION CUTTINGS SIZES**

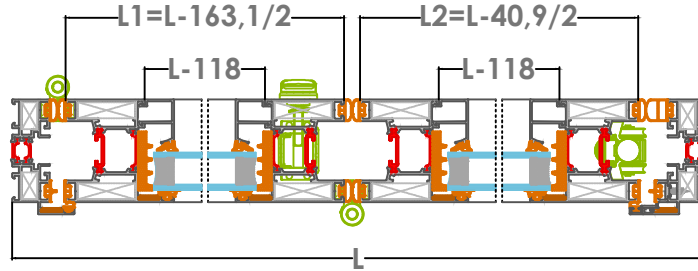

TİP: 2+0
TYPE: 2+0

PROFİLLER / PROFILES				
ADET UNIT	KOD CODE	TANIM DESCRIPTION	KESİM ÖLÇÜSÜ CUTTING SIZE	KESİM AÇISI CUTTING ANGLE
2	P 3000	DÜŞEY KASA / VERTICAL FRAME	H	45°/45°
2		YATAY KASA / HORIZONTAL FRAME	L	45°/45°
2	P 3001	DÜŞEY KANAT / VERTICAL SASH	H1=H-80	45°/45°
2		YATAY KANAT / HORIZONTAL SASH	L1=(L-163,1)/2	45°/45°
2	P 3001	DÜŞEY KANAT / VERTICAL SASH	H2=H-80	45°/45°
2		YATAY KANAT / HORIZONTAL SASH	L2=(L-40,9)/2	45°/45°
1	P 3019	ADAPTÖR PROFİLİ / ADAPTER PROFILE	H-56	90°/90°
2	P 1158	DÜŞEY CAM ÇİTASI / VERTICAL GLAZING BEAD PROFILE	H1-162	90°/90°
2		YATAY CAM ÇİTASI / HORIZONTAL GLAZING BEAD PROFILE	L1-118	90°/90°
2	P 1158	DÜŞEY CAM ÇİTASI / VERTICAL GLAZING BEAD PROFILE	H2-162	90°/90°
2		YATAY CAM ÇİTASI / HORIZONTAL GLAZING BEAD PROFILE	L2-118	90°/90°

AKSESUARLAR / ACCESSORIES			
ADET UNIT	KOD CODE	TANIM DESCRIPTION	KESİM ÖLÇÜSÜ CUTTING SIZE
2	702 212	ÇELİK RAY / STEEL RAIL	L-42
8	702 217	ALÜMİNYUM KÖŞE TAKOZU / 11,5 mm L:20,2 mm ALUMINIUM CORNER CLEAT	-
16	702 216	ALÜMİNYUM KÖŞE TAKOZU / 42,6 mm L:12 mm ALUMINIUM CORNER CLEAT	-
7	702 214	SU TAHLİYE KAPAĞI / WATER DRAINAGE CAP	-
12	702 215	KÖŞE ÇAVUŞU / CORNER CONNECTION	-
8	702 213	CAM TAKOZU / GLAZING WEDGE	-
1	702 202	KATLANIR KAPI ALT SON ARABA / FOLDING DOOR LOWER TROLLEY	-
1	702 203	KATLANIR KAPI ÜST SON ARABA / FOLDING DOOR UPPER TROLLEY	-
6	702 201	KATLANIR KAPI MENTEŞESİ / FOLDING DOOR HINGE	-
1	702 205	KATLANIR KAPI KİLİTLEME SETİ / FOLDING DOOR LOCKING SET	-
1	702 211	130 mm MİNİMAL KOL / 130 mm MINIMAL HANDLE	-

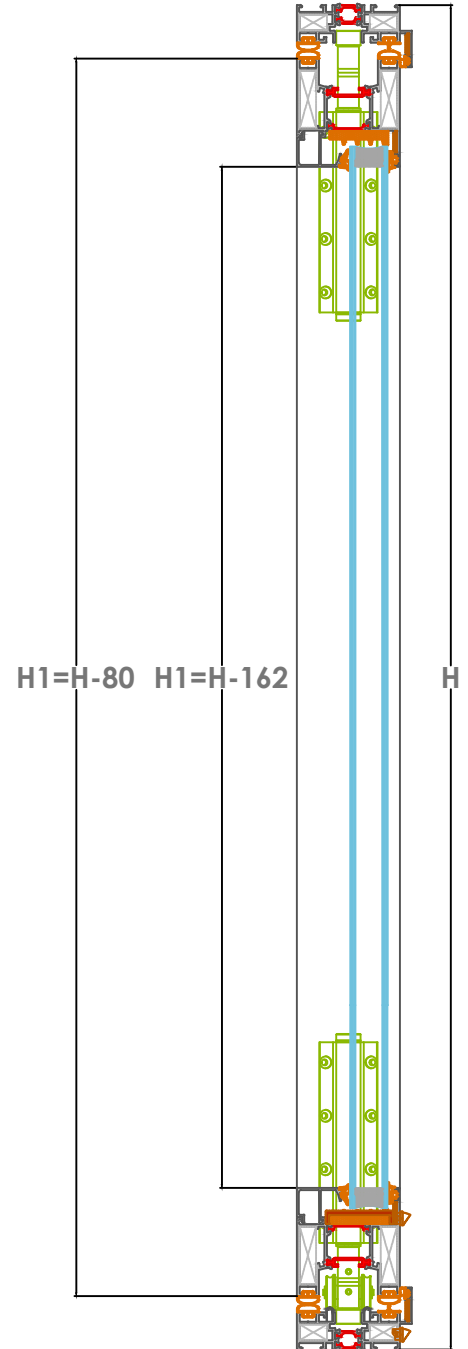

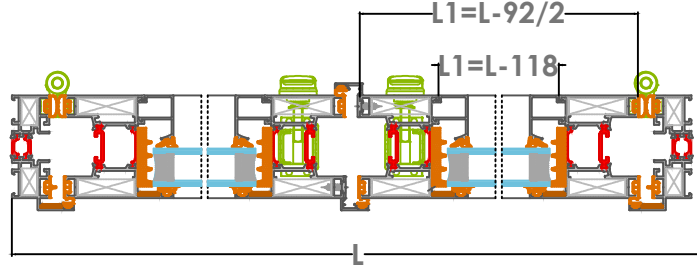

TİP: 1+1
TYPE: 1+1

PROFİLLER / PROFILES				
ADET UNIT	KOD CODE	TANIM DESCRIPTION	KESİM ÖLÇÜSÜ CUTTING SIZE	KESİM AÇISI CUTTING ANGLE
2	P 3000	DÜŞEY KASA / VERTICAL FRAME	H	45°/45°
2		YATAY KASA / HORIZONTAL FRAME	L	45°/45°
2	P 3001	DÜŞEY KANAT / VERTICAL SASH	H1=H-80	45°/45°
2		YATAY KANAT / HORIZONTAL SASH	L1=(L-92)/2	45°/45°
1	P 3018	ADAPTÖR PROFİLİ / ADAPTER PROFILE	H1=H-80	90°/90°
1		ADAPTÖR PROFİLİ / ADAPTER PROFILE	H-105	90°/90°
2	P 1158	DÜŞEY CAM ÇITASI / VERTICAL GLAZING BEAD PROFILE	H1=H-162	90°/90°
2		YATAY CAM ÇITASI / HORIZONTAL GLAZING BEAD PROFILE	L1=L-118	90°/90°

AKSESUARLAR / ACCESSORIES			
ADET UNIT	KOD CODE	TANIM DESCRIPTION	KESİM ÖLÇÜSÜ CUTTING SIZE
2	702 212	ÇELİK RAY / STEEL RAIL	L-42
8	702 217	ALÜMİNYUM KÖŞE TAKOZU / 11,5 mm L:20,2 mm ALUMINIUM CORNER CLEAT	-
16	702 216	ALÜMİNYUM KÖŞE TAKOZU / 42,6 mm L:12 mm ALUMINIUM CORNER CLEAT	-
7	702 214	SU TAHLİYE KAPAĞI / WATER DRAINAGE CAP	-
12	702 215	KÖŞE ÇAVUŞU / CORNER CONNECTION	-
8	702 213	CAM TAKOZU / GLAZING WEDGE	-
8	702 201	KATLANIR KAPI MENTEŞESİ / FOLDING DOOR HINGE	-
2	702 205	KATLANIR KAPI KİLİTLEME SETİ / FOLDING DOOR LOCKING SET	-
2	702 211	130 mm MİNİMAL KOL / 130 mm MINIMAL HANDLE	-
2	702 219	ADAPTÖR ÜST ve ALT KAPAĞI / ADAPTER BOTTOM and TOP CAP	-

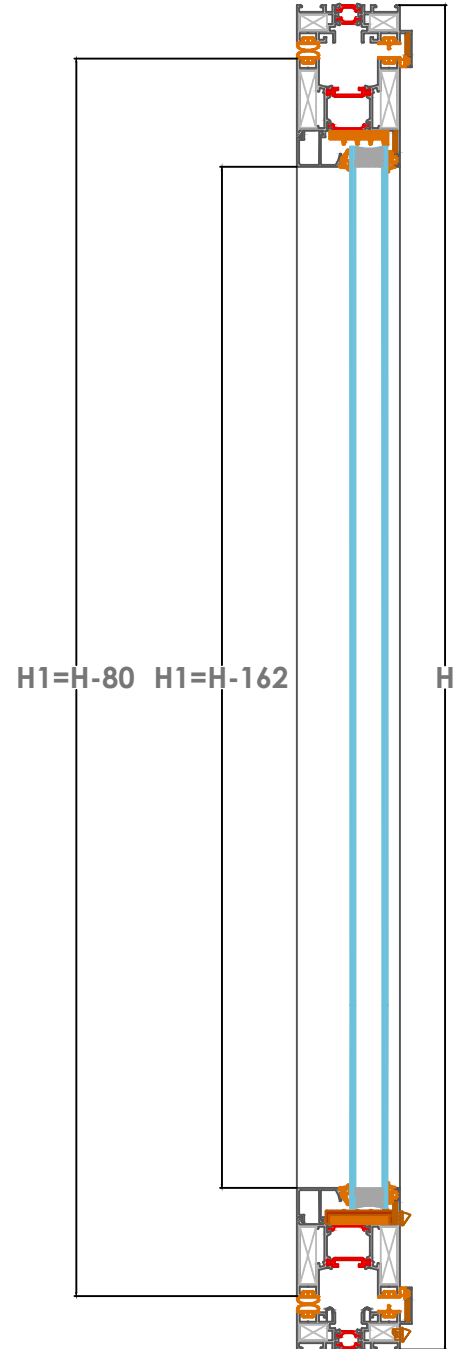

TİP: 3+0
TYPE: 3+0

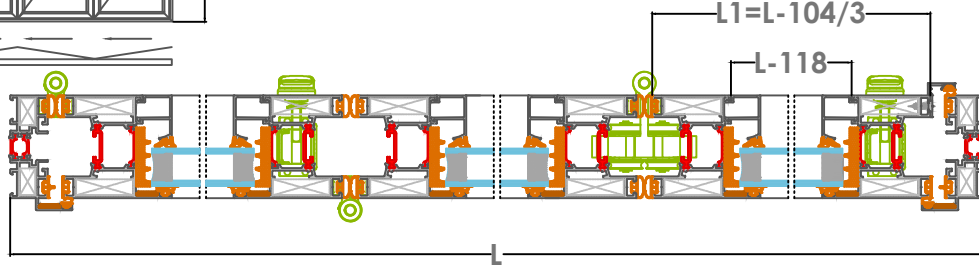
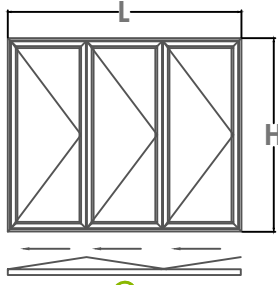

PROFİLLER / PROFILES				
ADET UNIT	KOD CODE	TANIM DESCRIPTION	KESİM ÖLÇÜSÜ CUTTING SIZE	KESİM AÇISI CUTTING ANGLE
2	P 3000	DÜŞEY KASA / VERTICAL FRAME	H	45°/45°
2		YATAY KASA / HORIZONTAL FRAME	L	45°/45°
6	P 3001	DÜŞEY KANAT / VERTICAL SASH	H1=H-80	45°/45°
6		YATAY KANAT / HORIZONTAL SASH	L1=(L-104)/3	45°/45°
1	P 3018	ADAPTÖR PROFİLİ / ADAPTER PROFILE	H1=H-80	90°/90°
6	P 1158	DÜŞEY CAM ÇİTASI / VERTICAL GLAZING BEAD PROFILE	H1=H-162	90°/90°
6		YATAY CAM ÇİTASI / HORIZONTAL GLAZING BEAD PROFILE	L1=L-118	90°/90°

AKSESUARLAR / ACCESSORIES			
ADET UNIT	KOD CODE	TANIM DESCRIPTION	KESİM ÖLÇÜSÜ CUTTING SIZE
2	702 212	ÇELİK RAY / STEEL RAIL	L-42
8	702 217	ALÜMİNYUM KÖŞE TAKOZU / 11,5 mm L:20,2 mm ALUMINIUM CORNER CLEAT	-
24	702 216	ALÜMİNYUM KÖŞE TAKOZU / 42,6 mm L:12 mm ALUMINIUM CORNER CLEAT	-
7	702 214	SU TAHLİYE KAPAĞI / WATER DRAINAGE CAP	-
16	702 215	KÖŞE ÇAVUŞU / CORNER CONNECTION	-
12	702 213	CAM TAKOZU / GLAZING WEDGE	-
10	702 201	KATLANIR KAPI MENTEŞESİ / FOLDING DOOR HINGE	-
1	702 206	KATLANIR KAPI ALT ARA ARABA / FOLDING DOOR LOWER TROLLEY	-
1	702 204	KATLANIR KAPI ÜST ARA ARABA / FOLDING DOOR UPPER TROLLEY	-
2	702 205	KATLANIR KAPI KİLİTLEME SETİ / FOLDING DOOR LOCKING SET	-
2	702 211	130 mm MİNİMAL KOL / 130 mm MINIMAL HANDLE	-
1	702 219	ADAPTÖR ÜST ve ALT KAPAĞI / ADAPTER BOTTOM and TOP CAP	-

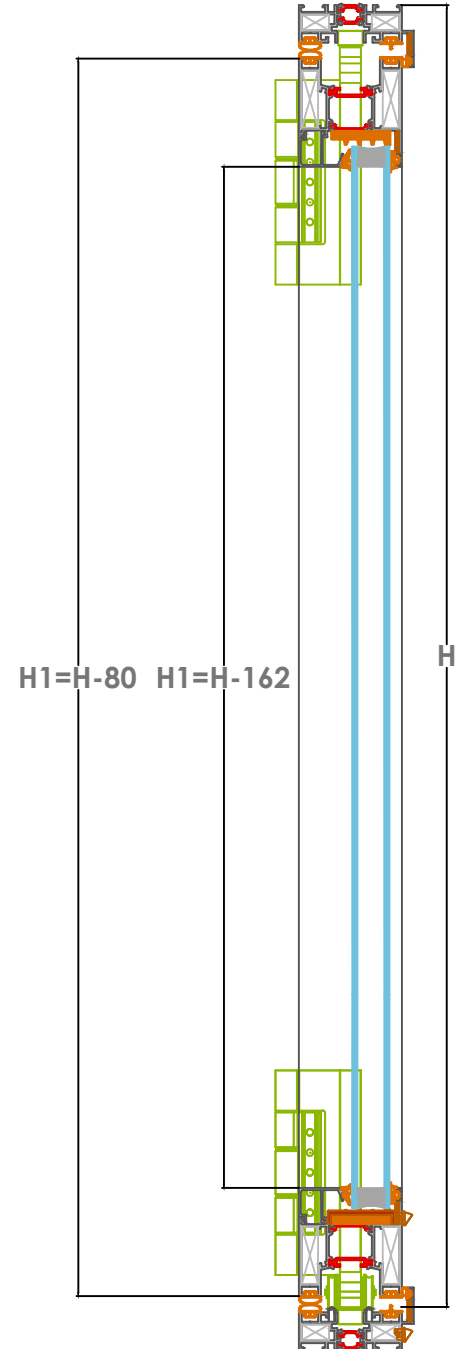

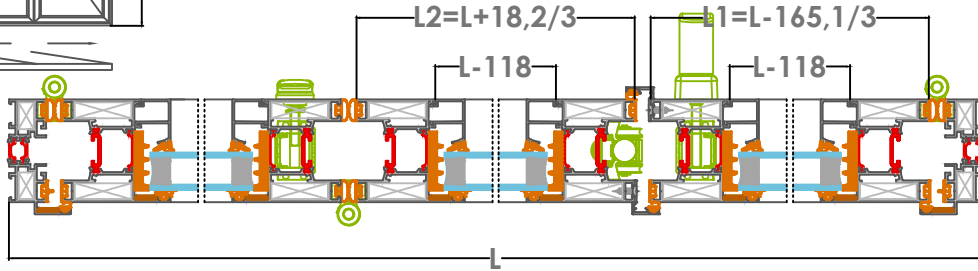
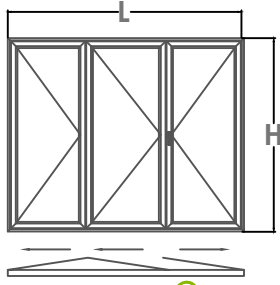

PROFİLLER / PROFILES				
ADET UNIT	KOD CODE	TANIM DESCRIPTION	KESİM ÖLÇÜSÜ CUTTING SIZE	KESİM AÇISI CUTTING ANGLE
2	P 3000	DÜŞEY KASA / VERTICAL FRAME	H	45°/45°
2		YATAY KASA / HORIZONTAL FRAME	L	45°/45°
4	P 3001	DÜŞEY KANAT / VERTICAL SASH	H1-80	45°/45°
4		YATAY KANAT / HORIZONTAL SASH	$L1=(L-165,1)/3$	45°/45°
2	P 3001	DÜŞEY KANAT / VERTICAL SASH	H2-80	45°/45°
2		YATAY KANAT / HORIZONTAL SASH	$L2=(L+18,2)/3$	45°/45°
1	P 3018	ADAPTÖR PROFİLİ / ADAPTER PROFILE	H2=H-80	90°/90°
1			H-105	90°/90°
4	P 1158	DÜŞEY CAM ÇİTASI / VERTICAL GLAZING BEAD PROFILE	H1=H-162	90°/90°
4		YATAY CAM ÇİTASI / HORIZONTAL GLAZING BEAD PROFILE	L1=L-118	90°/90°
2	P 1158	DÜŞEY CAM ÇİTASI / VERTICAL GLAZING BEAD PROFILE	H2=H-162	90°/90°
2		YATAY CAM ÇİTASI / HORIZONTAL GLAZING BEAD PROFILE	L2=L-118	90°/90°

AKSESUARLAR / ACCESSORIES				
ADET UNIT	KOD CODE	TANIM DESCRIPTION	KESİM ÖLÇÜSÜ CUTTING SIZE	
2	702 212	ÇELİK RAY / STEEL RAIL	L-42	
8	702 217	ALÜMİNYUM KÖŞE TAKOZU / 11,5 mm L:20,2 mm ALUMINIUM CORNER CLEAT	-	
24	702 216	ALÜMİNYUM KÖŞE TAKOZU / 42,6 mm L:12 mm ALUMINIUM CORNER CLEAT	-	
7	702 214	SU TAHLİYE KAPAĞI / WATER DRAINAGE CAP	-	
16	702 215	KÖŞE ÇAVUŞU / CORNER CONNECTION	-	
12	702 213	CAM TAKOZU / GLAZING WEDGE	-	
12	702 201	KATLANIR KAPI MENTEŞESİ / FOLDING DOOR HINGE	-	
1	702 202	KATLANIR KAPI ALT SON ARABA / FOLDING DOOR LOWER TROLLEY	-	
1	702 203	KATLANIR KAPI ÜST SON ARABA / FOLDING DOOR UPPER TROLLEY	-	
2	702 205	KATLANIR KAPI KİLİTLEME SETİ / FOLDING DOOR LOCKING SET	-	
2	702 211	130 mm MİNİMAL KOL / 130 mm MINIMAL HANDLE	-	
2	702 219	ADAPTÖR ÜST ve ALT KAPAĞI / ADAPTER BOTTOM and TOP CAP	-	

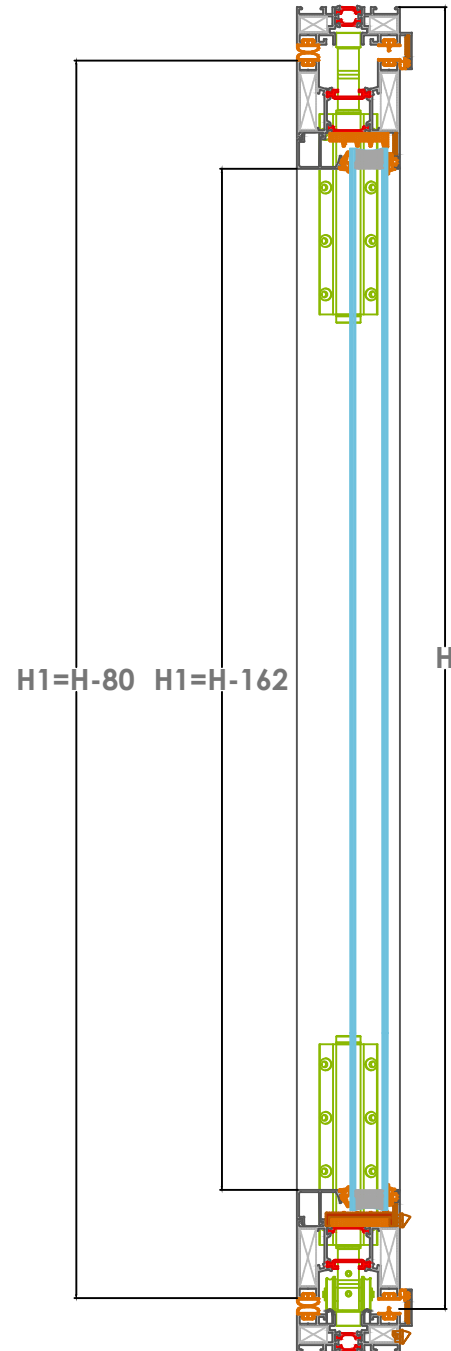

TİP: 4+0
TYPE: 4+0

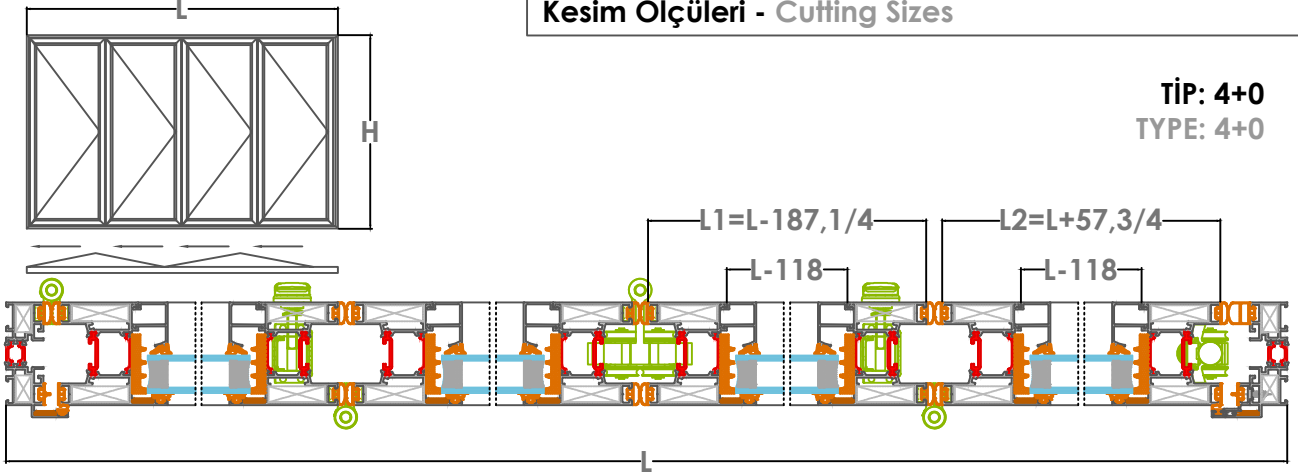

PROFİLLER / PROFILES				
ADET UNIT	KOD CODE	TANIM DESCRIPTION	KESİM ÖLÇÜSÜ CUTTING SIZE	KESİM AÇISI CUTTING ANGLE
2	P 3000	DÜŞEY KASA / VERTICAL FRAME	H	45°/45°
2		YATAY KASA / HORIZONTAL FRAME	L	45°/45°
6	P 3001	DÜŞEY KANAT / VERTICAL SASH	H1-80	45°/45°
6		YATAY KANAT / HORIZONTAL SASH	$L1=(L-187,1)/4$	45°/45°
2	P 3001	DÜŞEY KANAT / VERTICAL SASH	H2-80	45°/45°
2		YATAY KANAT / HORIZONTAL SASH	$L2=(L+57,3)/4$	45°/45°
1	P 3019	ADAPTÖR PROFİLİ / ADAPTER PROFILE	H-56	90°/90°
6	P 1158	DÜŞEY CAM ÇİTASI / VERTICAL GLAZING BEAD PROFILE	H1=H-162	90°/90°
6		YATAY CAM ÇİTASI / HORIZONTAL GLAZING BEAD PROFILE	L1=L-118	90°/90°
2	P 1158	DÜŞEY CAM ÇİTASI / VERTICAL GLAZING BEAD PROFILE	H2=H-162	90°/90°
2		YATAY CAM ÇİTASI / HORIZONTAL GLAZING BEAD PROFILE	L2=L-118	90°/90°

AKSESUARLAR / ACCESSORIES				
ADET UNIT	KOD CODE	TANIM DESCRIPTION	KESİM ÖLÇÜSÜ CUTTING SIZE	
2	702 212	ÇELİK RAY / STEEL RAIL	L-42	
8	702 217	ALÜMİNYUM KÖŞE TAKOZU / 11,5 mm L:20,2 mm ALUMINIUM CORNER CLEAT	-	
32	702 216	ALÜMİNYUM KÖŞE TAKOZU / 42,6 mm L:12 mm ALUMINIUM CORNER CLEAT	-	
7	702 214	SU TAHLİYE KAPAĞI / WATER DRAINAGE CAP	-	
20	702 215	KÖŞE ÇAVUŞU / CORNER CONNECTION	-	
16	702 213	CAM TAKOZU / GLAZING WEDGE	-	
14	702 201	KATLANIR KAPI MENTEŞESİ / FOLDING DOOR HINGE	-	
1	702 206	KATLANIR KAPI ALT ARA ARABA / FOLDING DOOR LOWER TROLLEY	-	
1	702 204	KATLANIR KAPI ÜST ARA ARABA / FOLDING DOOR UPPER TROLLEY	-	
1	702 202	KATLANIR KAPI ALT SON ARABA / FOLDING DOOR LOWER TROLLEY	-	
1	702 203	KATLANIR KAPI ÜST SON ARABA / FOLDING DOOR UPPER TROLLEY	-	
2	702 205	KATLANIR KAPI KİLİTLEME SETİ / FOLDING DOOR LOCKING SET	-	
2	702 211	130 mm MİNİMAL KOL / 130 mm MINIMAL HANDLE	-	
2	702 219	ADAPTÖR ÜST ve ALT KAPAĞI / ADAPTER BOTTOM and TOP CAP	-	

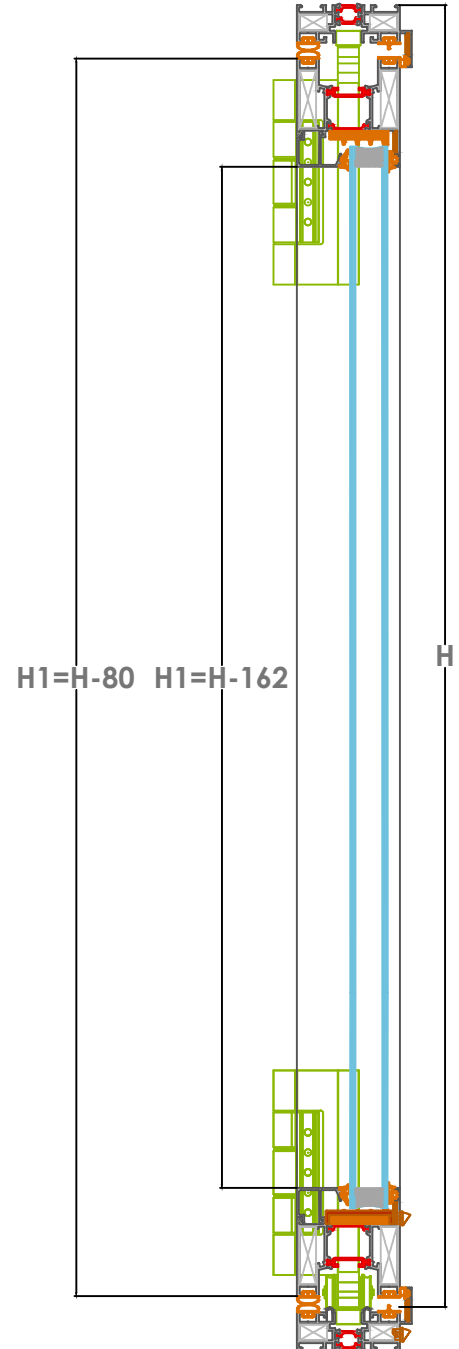

TİP: 3+1
TYPE: 3+1

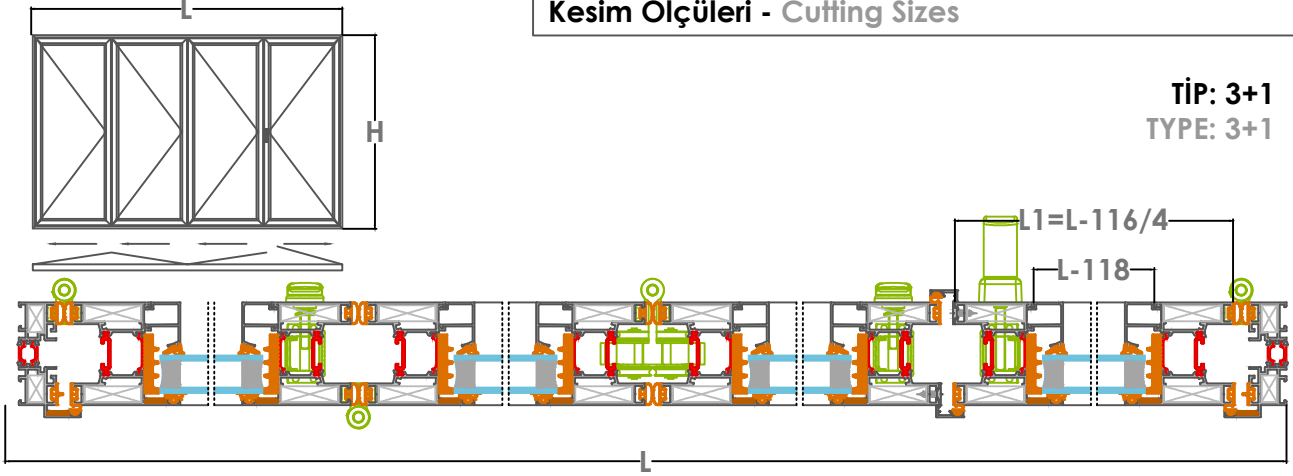

PROFİLLER / PROFILES				
ADET UNIT	KOD CODE	TANIM DESCRIPTION	KESİM ÖLÇÜSÜ CUTTING SIZE	KESİM AÇISI CUTTING ANGLE
2	P 3000	DÜŞEY KASA / VERTICAL FRAME	H	45°/45°
2		YATAY KASA / HORIZONTAL FRAME	L	45°/45°
8	P 3001	DÜŞEY KANAT / VERTICAL SASH	H1-80	45°/45°
8		YATAY KANAT / HORIZONTAL SASH	L1=(L-116)/4	45°/45°
1	P 3018	ADAPTÖR PROFİLİ / ADAPTER PROFILE	H-105	90°/90°
1			H1=H-80	90°/90°
8	P 1158	DÜŞEY CAM ÇİTASI / VERTICAL GLAZING BEAD PROFILE	H1=H-162	90°/90°
8		YATAY CAM ÇİTASI / HORIZONTAL GLAZING BEAD PROFILE	L1=L-118	90°/90°

AKSESUARLAR / ACCESSORIES			
ADET UNIT	KOD CODE	TANIM DESCRIPTION	KESİM ÖLÇÜSÜ CUTTING SIZE
2	702 212	ÇELİK RAY / STEEL RAIL	L-42
8	702 217	ALÜMİNYUM KÖŞE TAKOZU / 11,5 mm L:20,2 mm ALUMINIUM CORNER CLEAT	-
32	702 216	ALÜMİNYUM KÖŞE TAKOZU / 42,6 mm L:12 mm ALUMINIUM CORNER CLEAT	-
7	702 214	SU TAHLİYE KAPAĞI / WATER DRAINAGE CAP	-
20	702 215	KÖŞE ÇAVUŞU / CORNER CONNECTION	-
16	702 213	CAM TAKOZU / GLAZING WEDGE	-
14	702 201	KATLANIR KAPI MENTEŞESİ / FOLDING DOOR HINGE	-
1	702 206	KATLANIR KAPI ALT ARA ARABA / FOLDING DOOR LOWER TROLLEY	-
1	702 204	KATLANIR KAPI ÜST ARA ARABA / FOLDING DOOR UPPER TROLLEY	-
3	702 205	KATLANIR KAPI KİLİTLEME SETİ / FOLDING DOOR LOCKING SET	-
3	702 211	130 mm MİNİMAL KOL / 130 mm MINIMAL HANDLE	-
2	702 219	ADAPTÖR ÜST ve ALT KAPAĞI / ADAPTER BOTTOM and TOP CAP	-

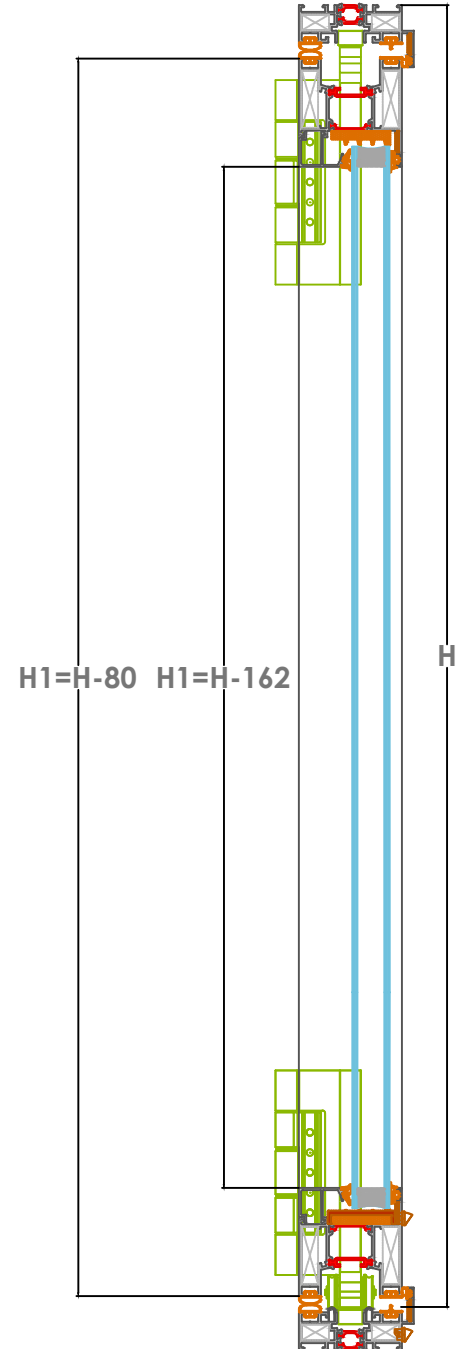

TİP: 2+2
TYPE: 2+2

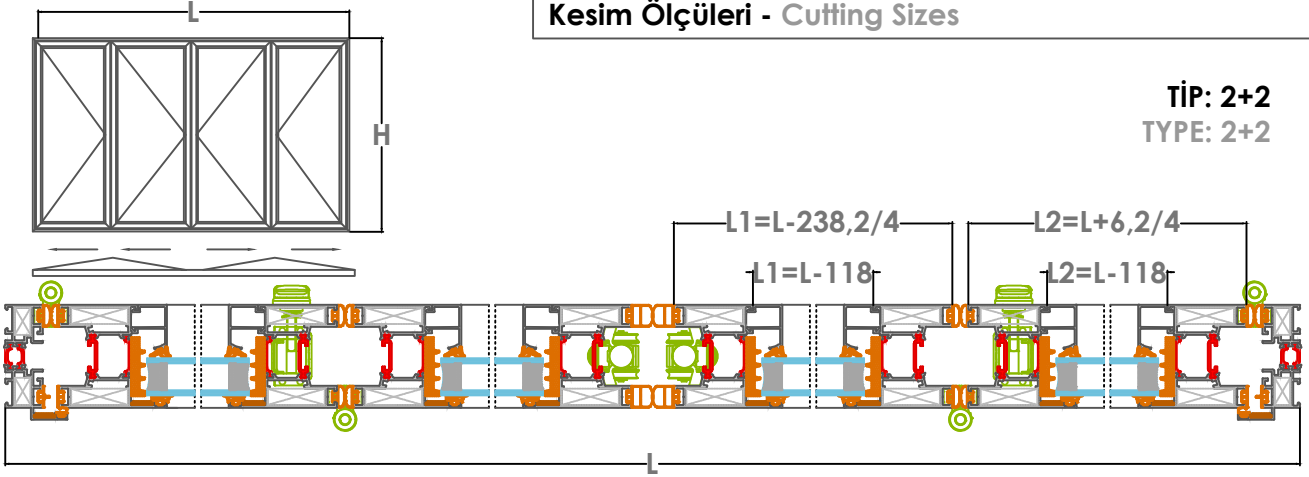

PROFİLLER / PROFILES				
ADET UNIT	KOD CODE	TANIM DESCRIPTION	KESİM ÖLÇÜSÜ CUTTING SIZE	KESİM AÇISI CUTTING ANGLE
2	P 3000	DÜŞEY KASA / VERTICAL FRAME	H	45°/45°
2		YATAY KASA / HORIZONTAL FRAME	L	45°/45°
6	P 3001	DÜŞEY KANAT / VERTICAL SASH	H1=H-80	45°/45°
6		YATAY KANAT / HORIZONTAL SASH	L1=(L-238,2)/4	45°/45°
2	P 3001	DÜŞEY KANAT / VERTICAL SASH	H2=H-80	45°/45°
2		YATAY KANAT / HORIZONTAL SASH	L2=(L+6,2)/4	45°/45°
6	P 1158	DÜŞEY CAM ÇİTASI / VERTICAL GLAZING BEAD PROFILE	H1=H-162	90°/90°
6		YATAY CAM ÇİTASI / HORIZONTAL GLAZING BEAD PROFILE	L1=L-118	90°/90°
2	P 1158	DÜŞEY CAM ÇİTASI / VERTICAL GLAZING BEAD PROFILE	H2=H-162	90°/90°
2		YATAY CAM ÇİTASI / HORIZONTAL GLAZING BEAD PROFILE	L2=L-118	90°/90°

AKSESUARLAR / ACCESSORIES				
ADET UNIT	KOD CODE	TANIM DESCRIPTION	KESİM ÖLÇÜSÜ CUTTING SIZE	
2	702 212	ÇELİK RAY / STEEL RAIL	L-42	
8	702 217	ALÜMİNYUM KÖŞE TAKOZU / 11,5 mm L:20,2 mm ALUMINIUM CORNER CLEAT	-	
32	702 216	ALÜMİNYUM KÖŞE TAKOZU / 42,6 mm L:12 mm ALUMINIUM CORNER CLEAT	-	
7	702 214	SU TAHLİYE KAPAĞI / WATER DRAINAGE CAP	-	
20	702 215	KÖŞE ÇAVUŞU / CORNER CONNECTION	-	
16	702 213	CAM TAKOZU / GLAZING WEDGE	-	
16	702 201	KATLANIR KAPI MENTEŞESİ / FOLDING DOOR HINGE	-	
2	702 202	KATLANIR KAPI ALT SON ARABA / FOLDING DOOR LOWER TROLLEY	-	
2	702 203	KATLANIR KAPI ÜST SON ARABA / FOLDING DOOR UPPER TROLLEY	-	
2	702 205	KATLANIR KAPI KİLİTLEME SETİ / FOLDING DOOR LOCKING SET	-	
2	702 211	130 mm MİNİMAL KOL / 130 mm MINIMAL HANDLE	-	

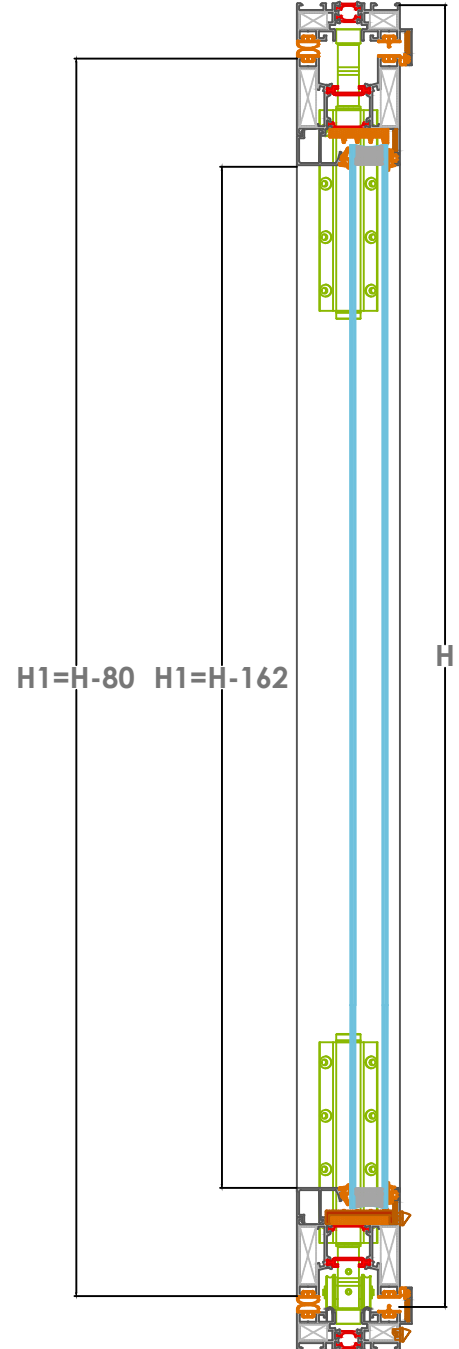

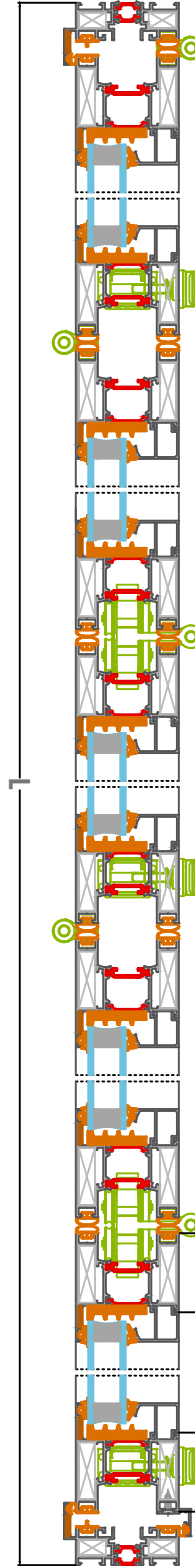
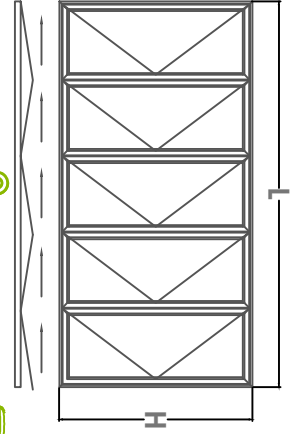

TIP: 5+0
TYPE: 5+0

PROFİLLER / PROFILES				
ADET UNIT	KOD CODE	TANIM DESCRIPTION	KESİM ÖLÇÜSÜ CUTTING SIZE	KESİM AÇISI CUTTING ANGLE
2	P 3000	DÜŞEY KASA / VERTICAL FRAME	H	45°/45°
2	P 3000	YATAY KASA / HORIZONTAL FRAME	L	45°/45°
10	P 3001	DÜŞEY KANAT / VERTICAL SASH	H1-80	45°/45°
10	P 3001	YATAY KANAT / HORIZONTAL SASH	L1=(L-128)/5	45°/45°
1	P 3018	ADAPTÖR PROFİLİ / ADAPTER PROFILE	H-105	90°/90°
10	P 1158	DÜŞEY CAM ÇITASI / VERTICAL GLAZING BEAD PROFILE	H1=H-162	90°/90°
10	P 1158	YATAY CAM ÇITASI / HORIZONTAL GLAZING BEAD PROFILE	L1=L-118	90°/90°

AKSESUARLAR / ACCESSORIES			
ADET UNIT	KOD CODE	TANIM DESCRIPTION	KESİM ÖLÇÜSÜ CUTTING SIZE
2	702 212	ÇELİK RAY / STEEL RAIL	L-42
8	702 217	ALÜMİNYUM KÖŞE TAKOZU / 11,5 mm L:20,2 mm ALUMINIUM CORNER CLEAT	-
40	702 216	ALÜMİNYUM KÖŞE TAKOZU / 42,6 mm L:12 mm ALUMINIUM CORNER CLEAT	-
8	702 214	SU TAHİLİYE KAPAĞI / WATER DRAINAGE CAP	-
24	702 215	KÖŞE ÇAVUŞU / CORNER CONNECTION	-
20	702 213	CAM TAKOZU / GLAZING WEDGE	-
16	702 201	KATLANIR KAPI MENTEŞESİ / FOLDING DOOR HINGE	-
2	702 206	KATLANIR KAPI ALT ARA ARABA / FOLDING DOOR LOWER TROLLEY	-
2	702 204	KATLANIR KAPI ÜST ARA ARABA / FOLDING DOOR UPPER TROLLEY	-
3	702 205	KATLANIR KAPI KİLİTLEME SETİ / FOLDING DOOR LOCKING SET	-
3	702 211	130 mm MİNİMAL KOL / 130 mm MİNİMAL HANDLE	-
1	702 219	ADAPTÖR ÜST ve ALT KAPAĞI / ADAPTER BOTTOM and TOP CAP	-

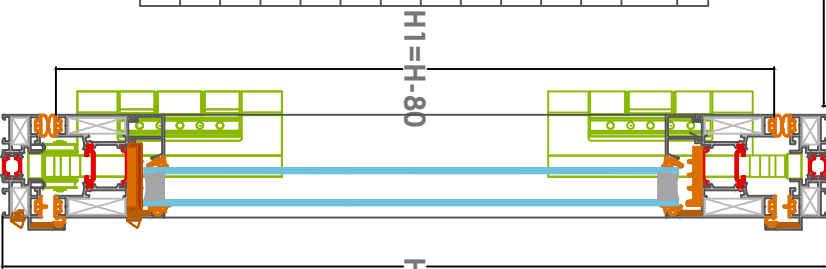

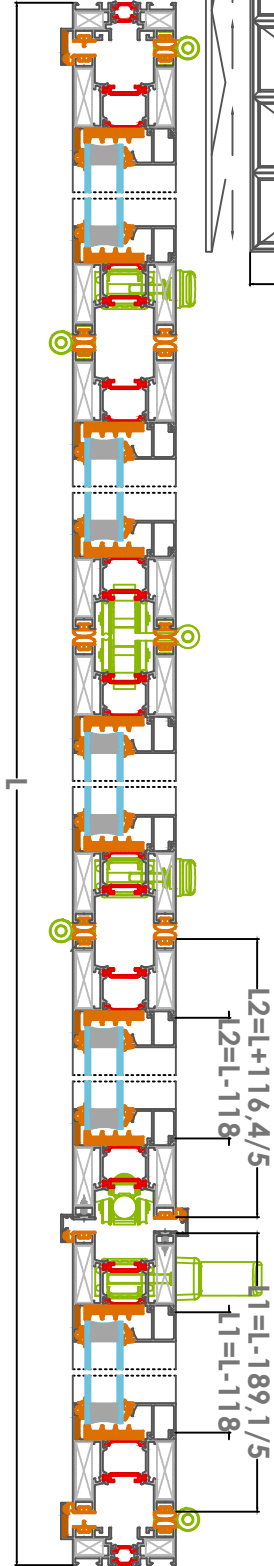
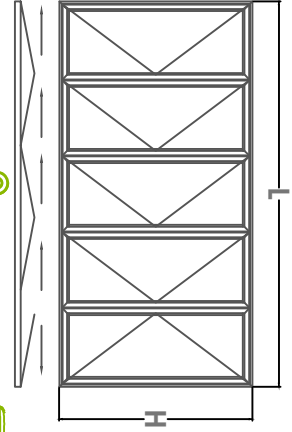

TİP: 4+1
TYPE: 4+1

ADET UNIT	KOD CODE	TANIM DESCRIPTION	KESİM ÖLÇÜSÜ CUTTING SIZE	KESİM AÇISI CUTTING ANGLE
2	P 3000	DÜŞEY KASA / VERTICAL FRAME	H	45°/45°
2	P 3000	YATAY KASA / HORIZONTAL FRAME	L	45°/45°
8	P 3001	DÜŞEY KANAT / VERTICAL SASH	H1-80	45°/45°
8	P 3001	YATAY KANAT / HORIZONTAL SASH	L1=(L-189,1)/5	45°/45°
2	P 3001	DÜŞEY KANAT / VERTICAL SASH	H2-80	45°/45°
2	P 3001	YATAY KANAT / HORIZONTAL SASH	L2=(L+116,4)/5	45°/45°
1	P 3018	ADAPTÖR PROFİLİ / ADAPTER PROFILE	H-80	90°/90°
1	P 3018	ADAPTÖR PROFİLİ / ADAPTER PROFILE	H-105	90°/90°
8	P 1158	DÜŞEY CAM ÇITASI / VERTICAL GLAZING BEAD PROFILE	H1=H-162	90°/90°
8	P 1158	YATAY CAM ÇITASI / HORIZONTAL GLAZING BEAD PROFILE	L1=L-118	90°/90°
2	P 1158	DÜŞEY CAM ÇITASI / VERTICAL GLAZING BEAD PROFILE	H1=H-162	90°/90°
2	P 1158	YATAY CAM ÇITASI / HORIZONTAL GLAZING BEAD PROFILE	L1=L-118	90°/90°

ADET UNIT	KOD CODE	TANIM DESCRIPTION	KESİM ÖLÇÜSÜ CUTTING SIZE
2	702 212	ÇELİK RAY / STEEL RAIL	L-42
8	702 217	ALÜMİNYUM KÖŞE TAKOZU / 11,5 mm L:20,2 mm ALÜMİNYUM CORNER CLEAT	-
40	702 216	ALÜMİNYUM KÖŞE TAKOZU / 42,6 mm L:12 mm ALÜMİNYUM CORNER CLEAT	-
7	702 214	SU TAHİLİYE KAPAĞI / WATER DRAINAGE CAP	-
24	702 215	KÖŞE ÇAVUŞU / CORNER CONNECTION	-
20	702 213	CAM TAKOZU / GLAZING WEDGE	-
18	702 201	KATLANIR KAPI MENTEŞESİ / FOLDING DOOR HINGE	-
1	702 206	KATLANIR KAPI ALT ARA ARABA / FOLDING DOOR LOWER ROLLET	-
1	702 204	KATLANIR KAPI ÜST ARA ARABA / FOLDING DOOR UPPER ROLLET	-
1	702 202	KATLANIR KAPI ALT SON ARABA / FOLDING DOOR LOWER ROLLET	-
1	702 203	KATLANIR KAPI ÜST SON ARABA / FOLDING DOOR UPPER ROLLET	-
3	702 205	KATLANIR KAPI KİLİTLEME SİLİ / FOLDING DOOR LOCKING SEI	-
3	702 211	130 mm MİNİMAL KOL / 130 mm MİNİMAL HANDLE	-
2	702 219	ADAPTÖR ÜST VE ALT KAPAĞI / ADAPTER BOTTOM and TOP CAP	-



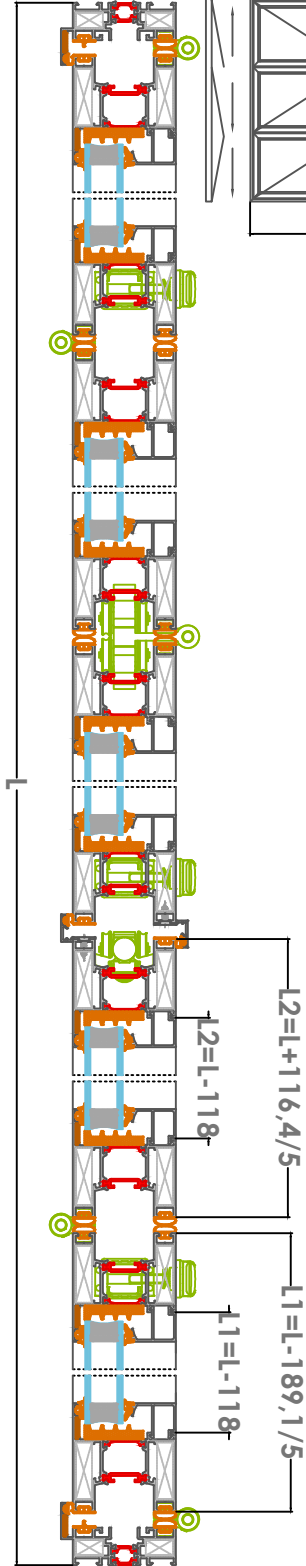
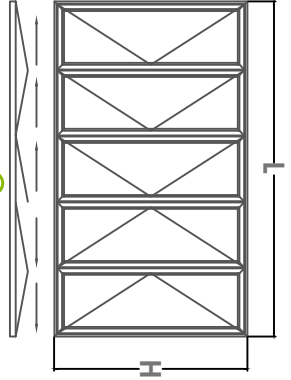

TİP: 3+2
TYPE: 3+2

ADDET UNIT	KOD CODE	TANIM DESCRIPTION	KESİM ÖLÇÜSÜ CUTTING SIZE	KESİM AÇISI CUTTING ANGLE
2	P 3000	DÜŞEY KASA / VERTICAL FRAME	H	45°/45°
2	P 3000	YATAY KASA / HORIZONTAL FRAME	L	45°/45°
8	P 3001	DÜŞEY KANAT / VERTICAL SASH	H1-80	45°/45°
8	P 3001	YATAY KANAT / HORIZONTAL SASH	L1=(L-189,1)/5	45°/45°
2	P 3001	DÜŞEY KANAT / VERTICAL SASH	H2-80	45°/45°
2	P 3001	YATAY KANAT / HORIZONTAL SASH	L2=(L+116,4)/5	45°/45°
1	P 3018	ADAPTÖR PROFİLİ / ADAPTER PROFILE	H-80	90°/90°
1	P 3018	ADAPTÖR PROFİLİ / ADAPTER PROFILE	H-105	90°/90°
8	P 1138	DÜŞEY CAM ÇITASI / VERTICAL GLAZING BEAD PROFILE	H1=H-162	90°/90°
8	P 1138	YATAY CAM ÇITASI / HORIZONTAL GLAZING BEAD PROFILE	L1=L-118	90°/90°
2	P 1138	DÜŞEY CAM ÇITASI / VERTICAL GLAZING BEAD PROFILE	H1=H-162	90°/90°
2	P 1138	YATAY CAM ÇITASI / HORIZONTAL GLAZING BEAD PROFILE	L1=L-118	90°/90°

ADDET UNIT	KOD CODE	TANIM DESCRIPTION	KESİM ÖLÇÜSÜ CUTTING SIZE
2	702 212	ÇELİK RAY / STEEL RAIL	L-42
8	702 217	ALÜMİNYUM KÖŞE TAKOZU / ALUMINIUM CORNER CLEAT	-
40	702 216	ALÜMİNYUM KÖŞE TAKOZU / ALUMINIUM CORNER CLEAT	-
9	702 214	SU TAHİTİYE KAPAĞI / WATER DRAINAGE CAP	-
24	702 215	KÖŞE ÇAVUŞU / CORNER CONNECTION	-
20	702 213	CAM TAKOZU / GLAZING WEDGE	-
18	702 201	KATLANIR KAPI MENTİŞESİ / FOLDING DOOR HINGE	-
1	702 206	KATLANIR KAPI ALT ARA ARABA / FOLDING DOOR LOWER ROLLER	-
1	702 204	KATLANIR KAPI ÜST ARA ARABA / FOLDING DOOR UPPER ROLLER	-
1	702 202	KATLANIR KAPI ALT SON ARABA / FOLDING DOOR LOWER ROLLER	-
1	702 203	KATLANIR KAPI ÜST SON ARABA / FOLDING DOOR UPPER ROLLER	-
3	702 205	KATLANIR KAPI KİLİTLEME SETİ / FOLDING DOOR LOCKING SET	-
3	702 211	130 mm MINİMAL KOL / 130 mm MINIMAL HANDLE	-
2	702 219	ADAPTÖR ÜST ve ALT KAPAĞI / ADAPTER BOTTOM and TOP CAP	-



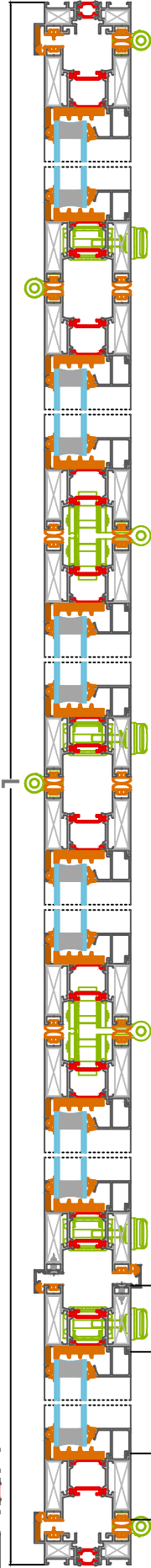
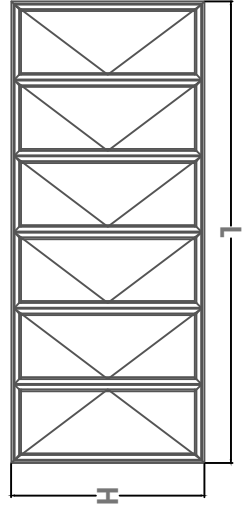

TİP: 5+1
TYPE: 5+1

L1=L-140/6

L1=L-118

H1=H-80

H

PROFİLLER / PROFILES				
ADET UNIT	KOD CODE	TANIM DESCRIPTION	KESİM ÖLÇÜSÜ CUTTING SIZE	KESİM AÇISI CUTTING ANGLE
2	P 3000	DÜŞEY KASA / VERTICAL FRAME	H	45°/45°
2		YATAY KASA / HORIZONTAL FRAME	L	45°/45°
8	P 3001	DÜŞEY KANAT / VERTICAL SASH	H1-80	45°/45°
8		YATAY KANAT / HORIZONTAL SASH	L1=(L-140)/6	45°/45°
1	P 3018	ADAPTÖR PROFİLİ / ADAPTER PROFILE	H1=H-80	90°/90°
1		ADAPTÖR PROFİLİ / ADAPTER PROFILE	H-105	90°/90°
8	P 1158	DÜŞEY CAM ÇITASI / VERTICAL GLAZING BEAD YATAY CAM ÇITASI / HORIZONTAL GLAZING BEAD	H1=H-162 L1=L-118	90°/90° 90°/90°

AKSESUARLAR / ACCESSORIES			
ADET UNIT	KOD CODE	TANIM DESCRIPTION	KESİM ÖLÇÜSÜ CUTTING SIZE
2	702 212	ÇELİK RAY / STEEL RAIL	L-42
8	702 217	ALÜMİNYUM KÖŞE TAKOZU / 11,5 mm L:20,2 mm ALUMINIUM CORNER CLEAT	-
48	702 216	ALÜMİNYUM KÖŞE TAKOZU / 42,6 mm L:12 mm ALUMINIUM CORNER CLEAT	-
7	702 214	SU TAHİLİYE KAPAĞI / WATER DRAINAGE CAP	-
28	702 215	KÖŞE ÇAVUŞU / CORNER CONNECTION	-
24	702 213	CAM TAKOZU / GLAZING WEDGE	-
20	702 201	KATILANIR KAPI MENTEŞESİ / FOLDING DOOR HINGE	-
2	702 206	KATILANIR KAPI ALT ARA ARABA / FOLDING DOOR LOWER TROLLEY	-
2	702 204	KATILANIR KAPI ÜST ARA ARABA / FOLDING DOOR UPPER TROLLEY	-
4	702 205	KATILANIR KAPI KİLİTLEME SETİ / FOLDING DOOR LOCKING SET	-
4	702 211	130 mm MINİMAL KOL / 130 mm MINIMAL HANDLE	-
2	702 219	ADAPTÖR ÜST ve ALT KAPAĞI / ADAPTER BOTTOM and TOP CAP	-



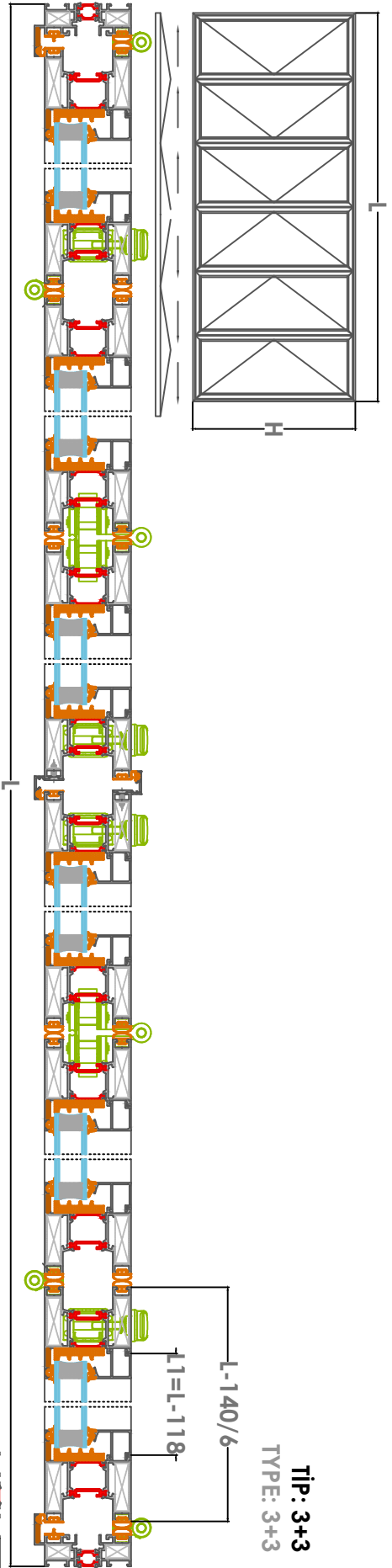

PROFİLER / PROFILES				
ADET UNIT	KOD CODE	TANIM DESCRIPTION	KESİM ÖLÇÜSÜ CUTTING SIZE	KESİM AÇISI CUTTING ANGLE
2	P 3000	DÜŞEY KASA / VERTICAL FRAME	H	45°/45°
2	P 3000	YATAY KASA / HORIZONTAL FRAME	L	45°/45°
12	P 3001	DÜŞEY KANAT / VERTICAL SASH	H1=H-80	45°/45°
12	P 3001	YATAY KANAT / HORIZONTAL SASH	L1=(L-140)/6	45°/45°
1	P 3018	ADAPTÖR PROFİLİ / ADAPTER PROFILE	H1=H-80	90°/90°
1	P 3018	ADAPTÖR PROFİLİ / ADAPTER PROFILE	H-105	90°/90°
12	P 1158	DÜŞEY CAM ÇITASI / VERTICAL GLAZING BEAD PROFİLİ YATAY CAM ÇITASI / HORIZONTAL GLAZING BEAD PROFİLİ	H1=H-162 L1=L-118	90°/90° 90°/90°

AKSESUARLAR / ACCESSORIES			
ADET UNIT	KOD CODE	TANIM DESCRIPTION	KESİM ÖLÇÜSÜ CUTTING SIZE
2	702 212	ÇELİK RAY / STEEL RAIL	L-42
8	702 217	ALÜMİNYUM KÖŞE TAKOZU / 11,5 mm L202 mm ALÜMİNYUM CORNER CLEAT	-
48	702 216	ALÜMİNYUM KÖŞE TAKOZU / 42,6 mm L12 mm ALÜMİNYUM CORNER CLEAT	-
7	702 214	SU TAHLİYE KAPAĞI / WATER DRAINAGE CAP	-
28	702 215	KÖŞE ÇAVUŞU / CORNER CONNECTION	-
24	702 213	CAM TAKOZU / GLAZING WEDGE	-
20	702 201	KATLANIR KAPI MENTİŞESİ / FOLDING DOOR HINGE	-
2	702 206	KATLANIR KAPI ALT ARA ARABA / FOLDING DOOR LOWER TROLLEY	-
2	702 204	KATLANIR KAPI ÜST ARA ARABA / FOLDING DOOR UPPER TROLLEY	-
4	702 205	KATLANIR KAPI KİLİTLEMİŞ SETİ / FOLDING DOOR LOCKING SET	-
4	702 211	130 mm MINİMAL KOL / 130 mm MINIMAL HANDLE	-
2	702 219	ADAPTÖR ÜST ve ALT KAPAĞI / ADAPTER BOTTOM and TOP CAP	-

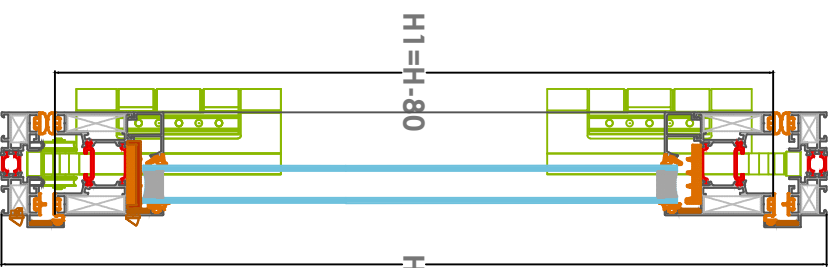

PANORAMA KATLANIR KAPI
İMALAT DETAYLARI
PANORAMA FOLDING DOOR
FABRICATION DETAILS

KASA MONTAJI (FRAME ASSEMBLY)

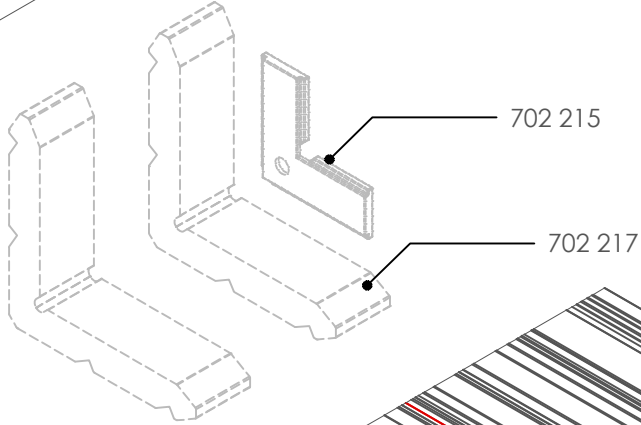
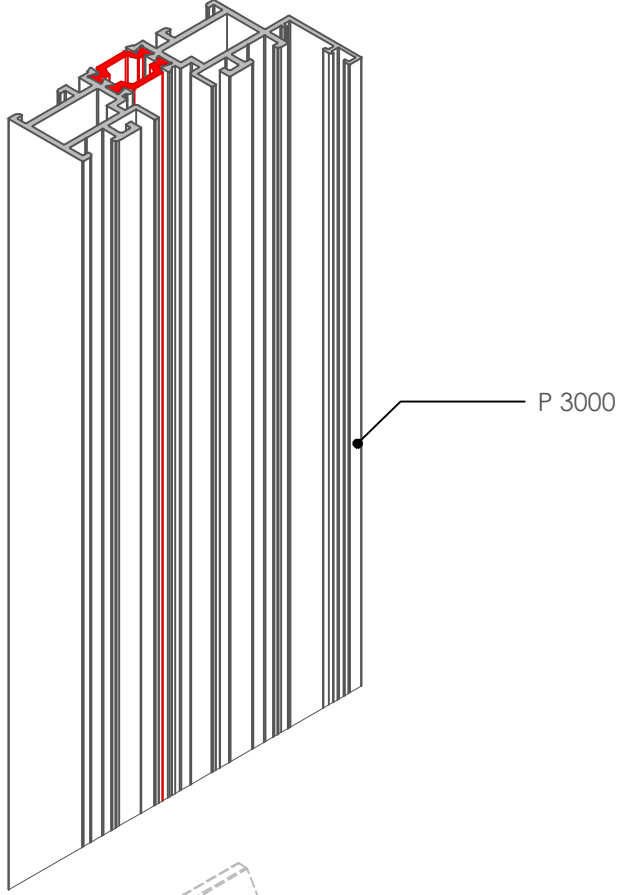

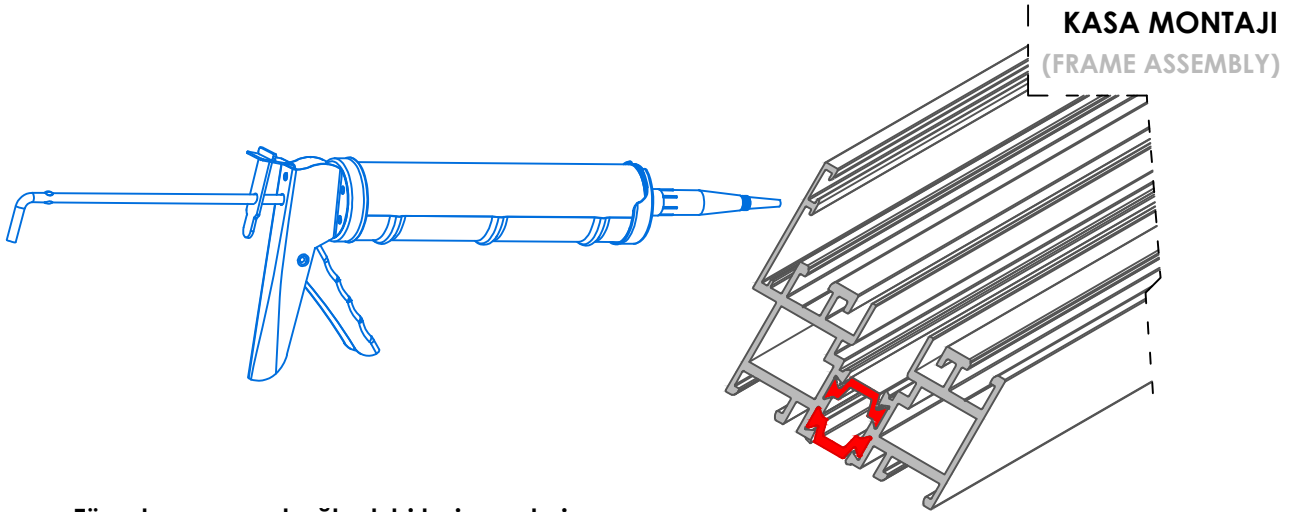

Tüm dış çerçeve bağlantı birleşim yerlerine ve çerçeve bileşenlerinin arasına poliüretan montaj yapıştırıcısı sürün.
Apply polyurethane assembly adhesive at all outer frame connection joints and between the frame components.

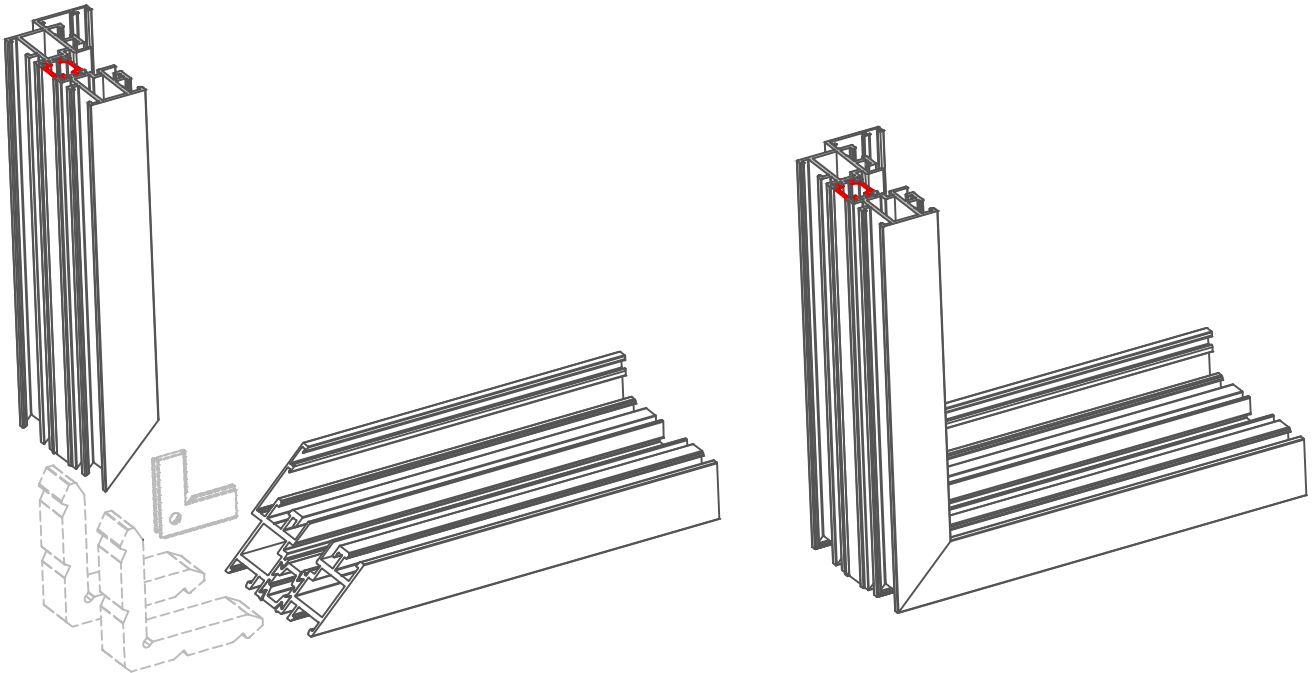

Kasa köşelerini köşe takozlar kullanarak bağlayın ve köşe pres makinesi yardımı ile presleyin.
Connect the corners of the frame using corner cleats and press them with the help of a corner press machine.

KASA MONTAJI (FRAME ASSEMBLY)

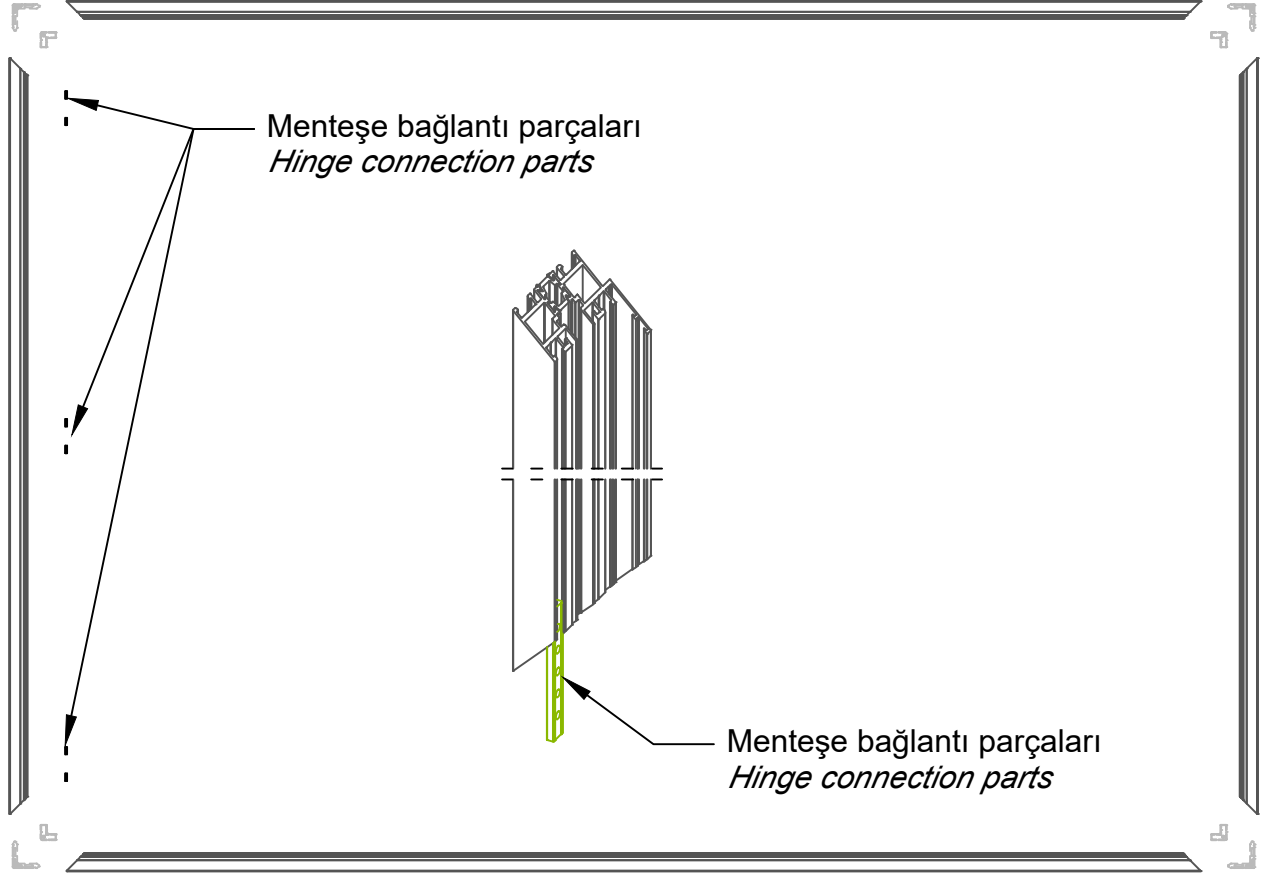

-Tüm dış çerçeve bağlantı noktalarında ve çerçeve bileşenleri arasında poliüretan montaj yapıştırıcısı uygulayın.
Apply polyurethane assembly adhesive at all outer frame connection joints and between the frame components.

Not: Köşe presleme yapmadan önce menteşe bağlantı parçalarını mutlaka kasa içine yerleştiriniz.
Note: Before connect the corners, be sure to place the hinge connecting parts inside the frame.

KASA MONTAJI (FRAME ASSEMBLY)

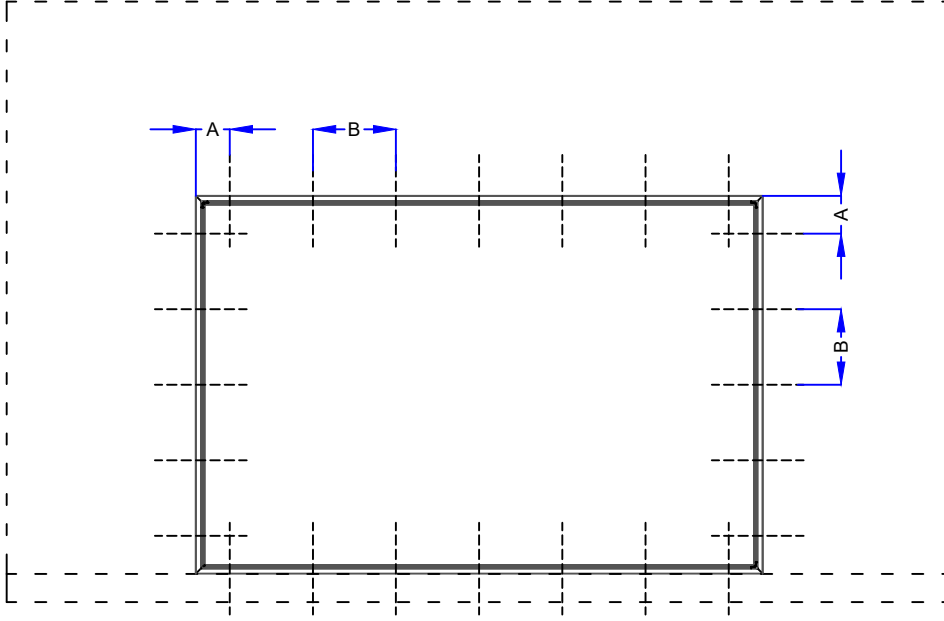

-Uygun sabitleme vidaları ve tapaları kullanarak çerçeveyi sabitleyin.

A= Vida mesafesi köşeden yaklaşık 150 mm uzaklıktadır.
B= Vidalar arası maksimum 500 mm olmalıdır.

-Secure frame using suitable fixing screws and plugs.

A=Anchor distance from corner of frame approximately 150mm.
B= Anchor spacing generally at maximum 500 mm.

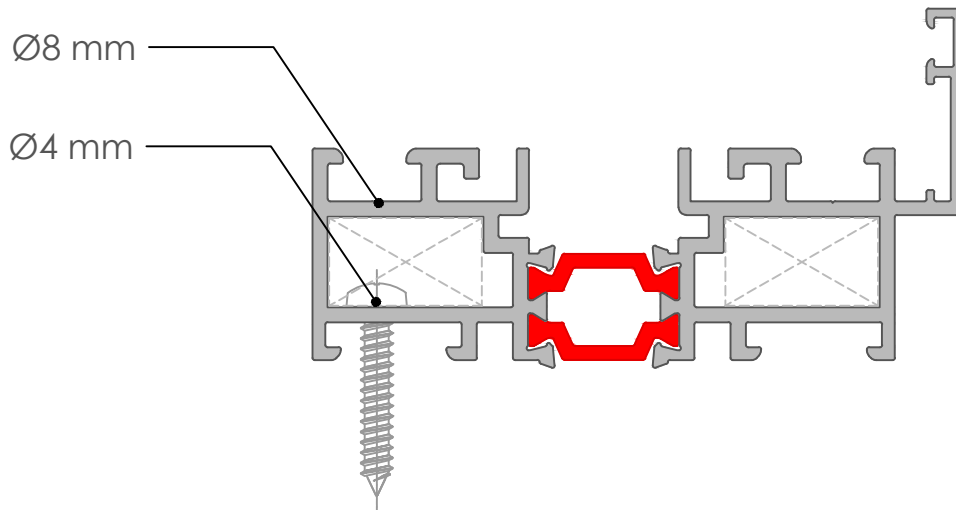

KANAT MONTAJI (SASH ASSEMBLY)

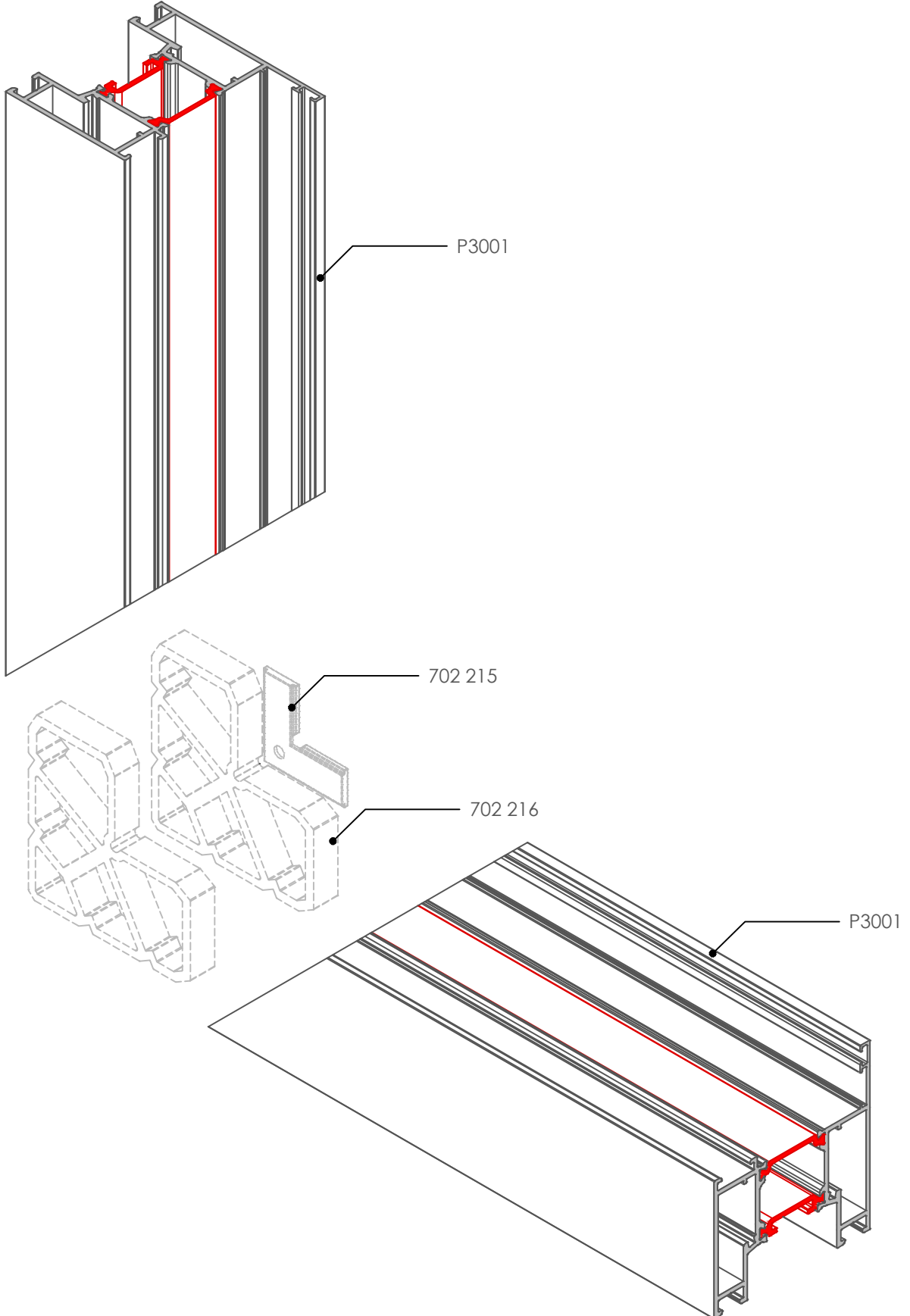

ORTA KAYIT BAĞLANTI MONTAJI (MULLION CONNECTION ASSEMBLY)

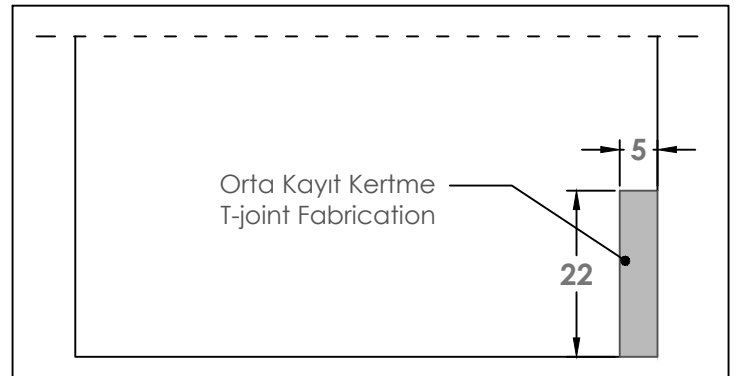
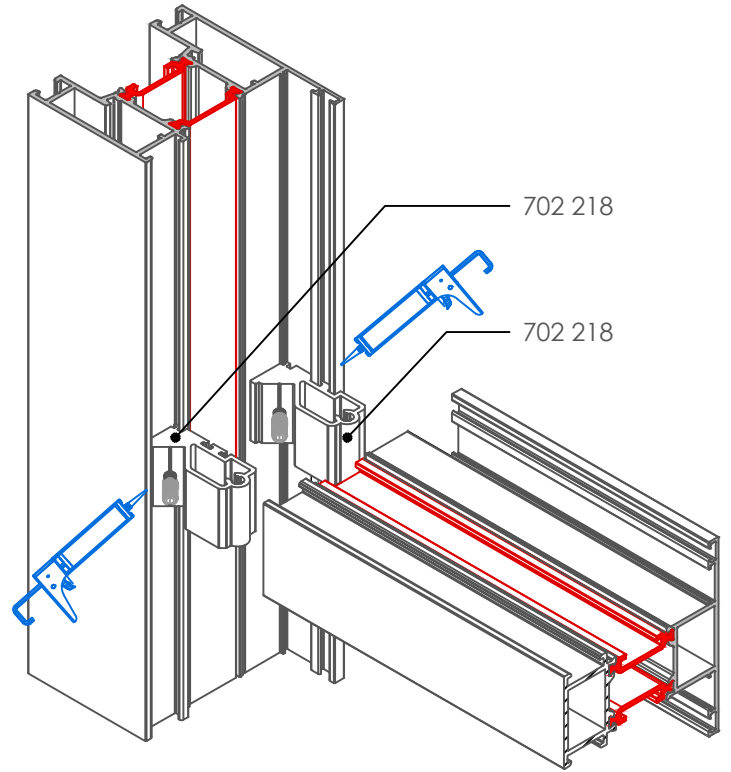
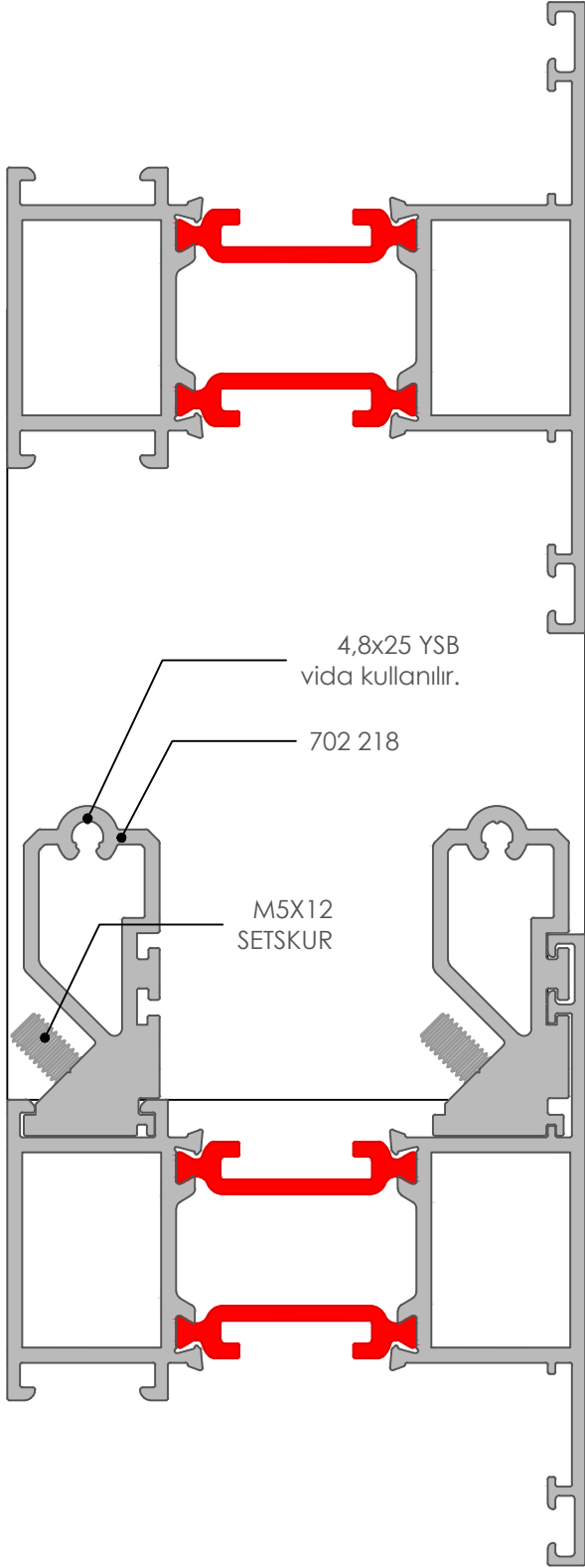

KANAT PROFİLİ SU TAHLİYE SLOTLARI (WATER DRAINAGE FOR SASH PROFILE)

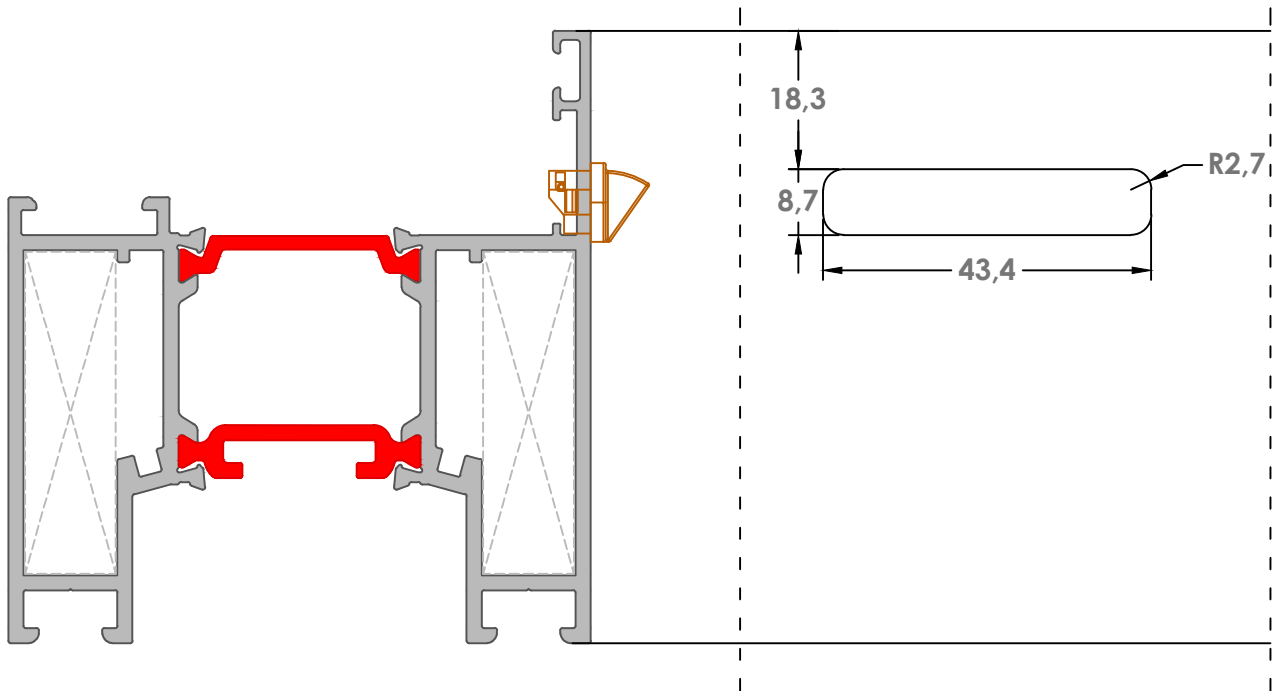
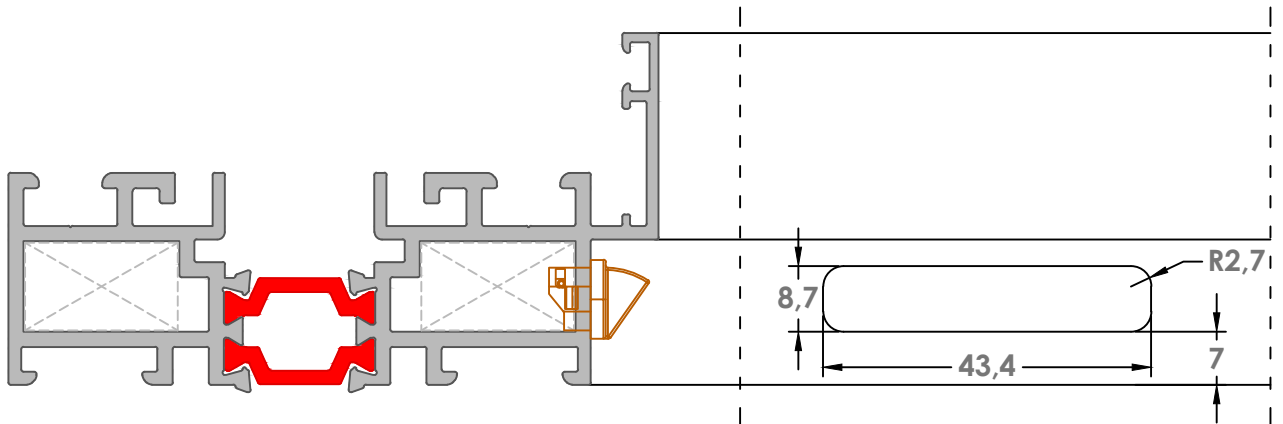
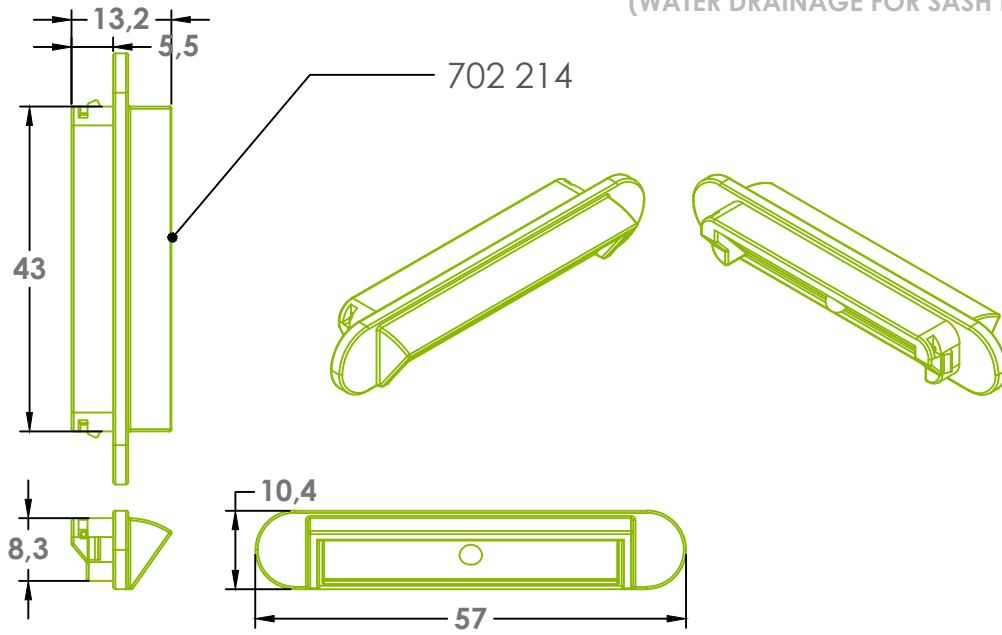

130 mm MİNİMAL KOL MONTAJ SLOTLARI (130 mm MINIMAL HANDLE ASSEMBLY)

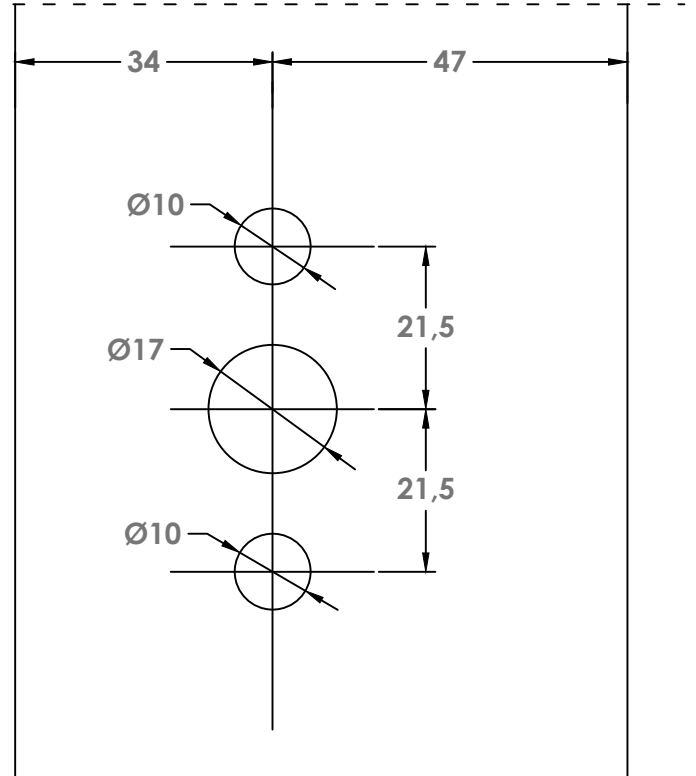
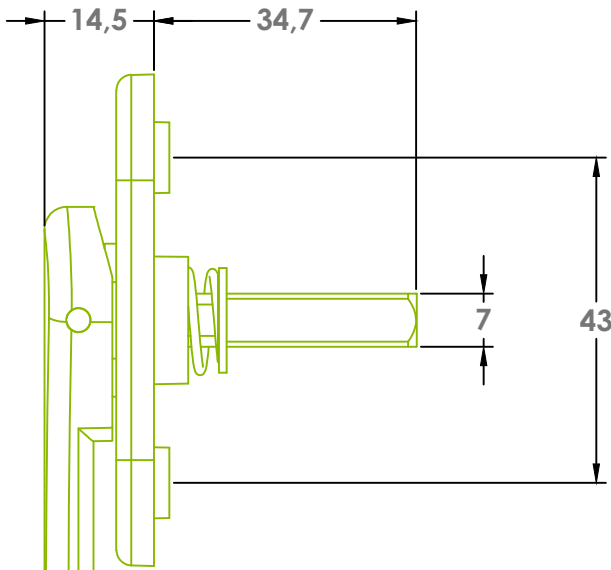
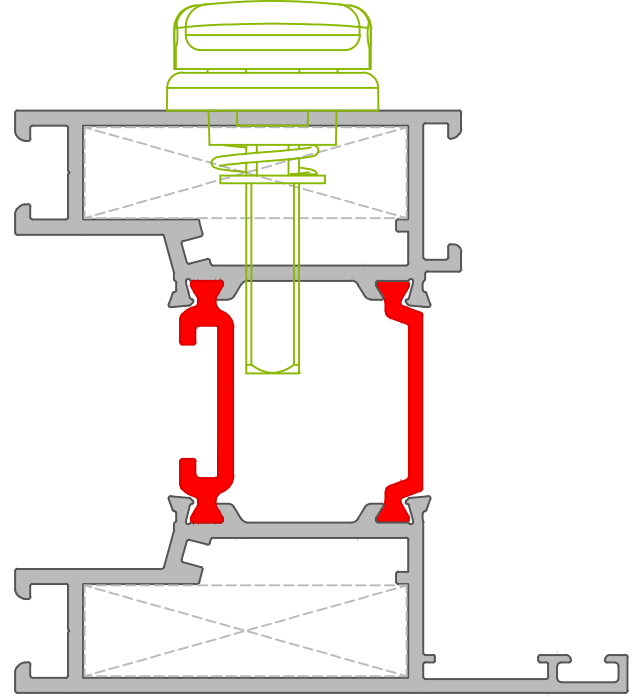
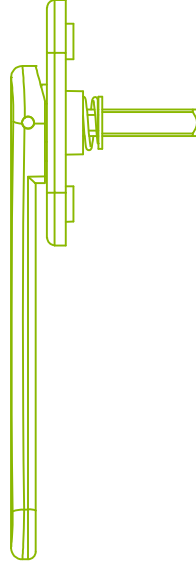
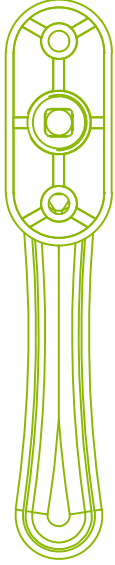

140 mm DÜZ KOL MONTAJ SLOTLARI (140 mm FLAT HANDLE ASSEMBLY)

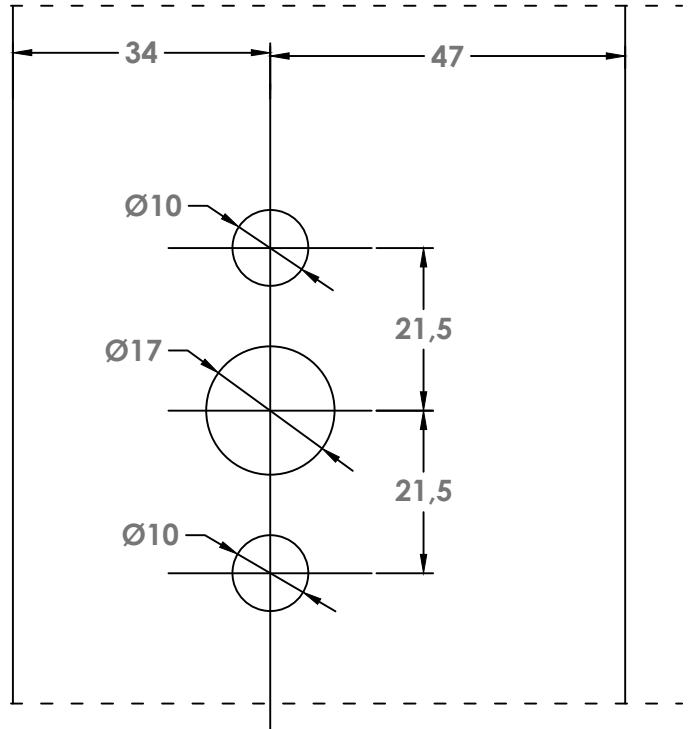
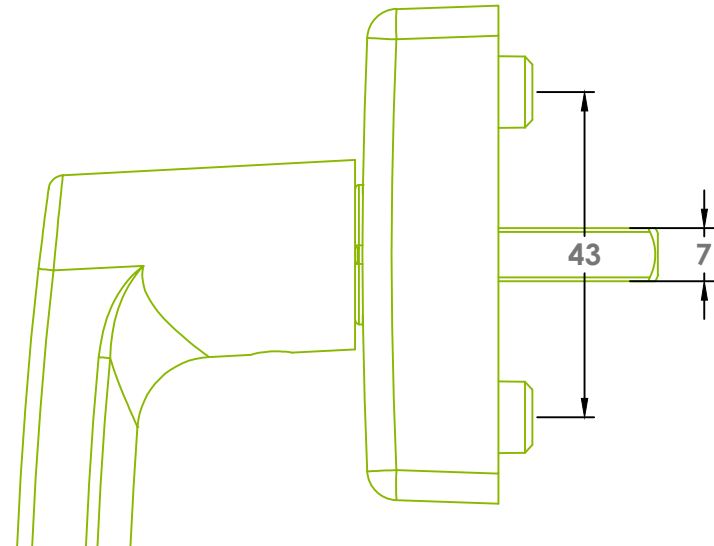
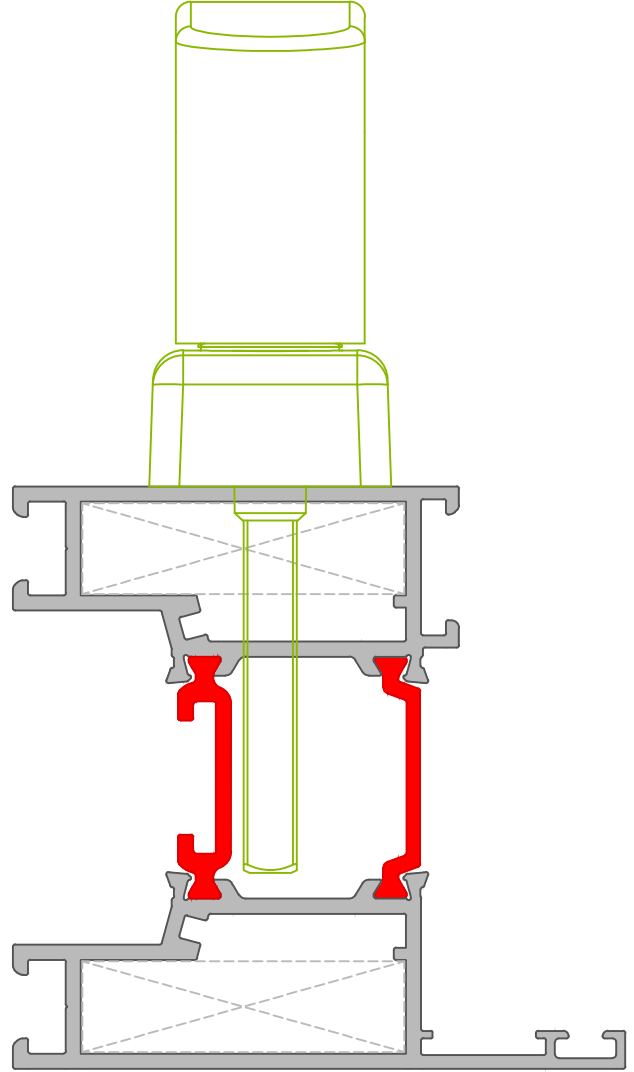
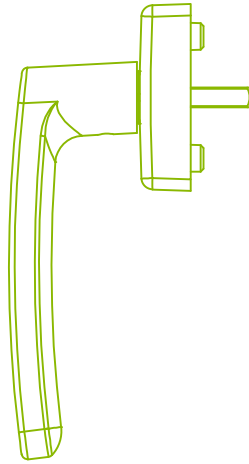
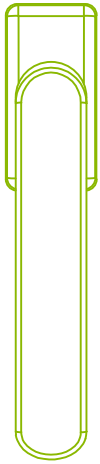
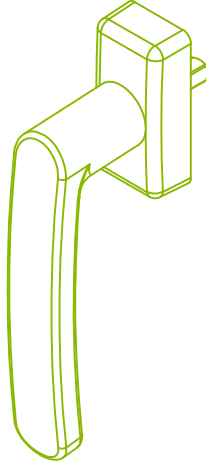

KİLİTLEME SETİ MONTAJ SLOTLARI (LOCKING SET ASSEMBLY)

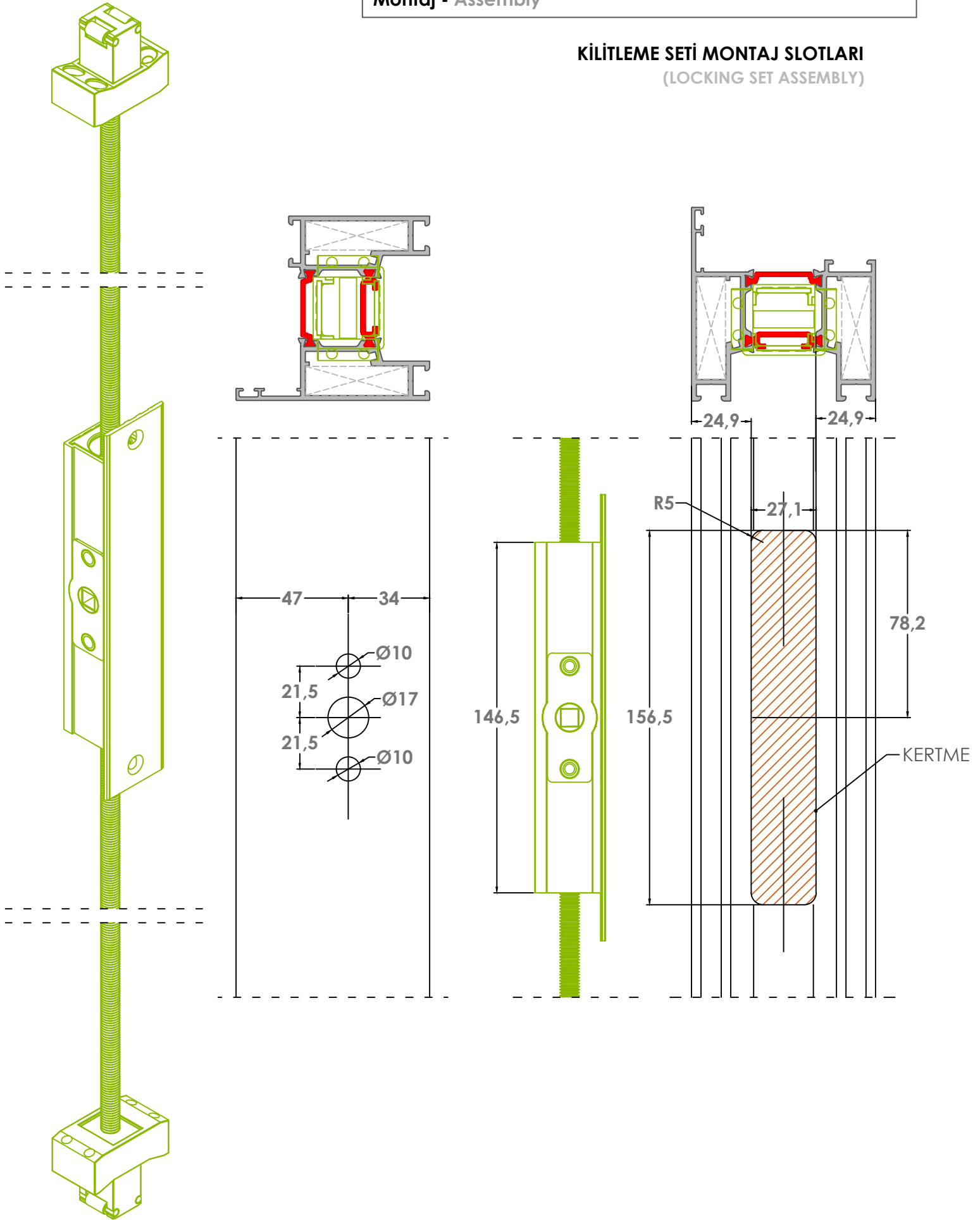

KİLİTLEME SETİ MONTAJ SLOTLARI

(LOCKING SET ASSEMBLY)

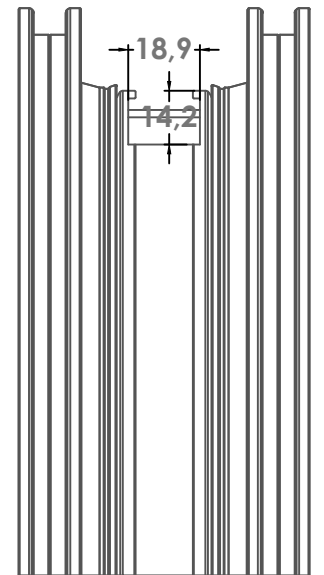
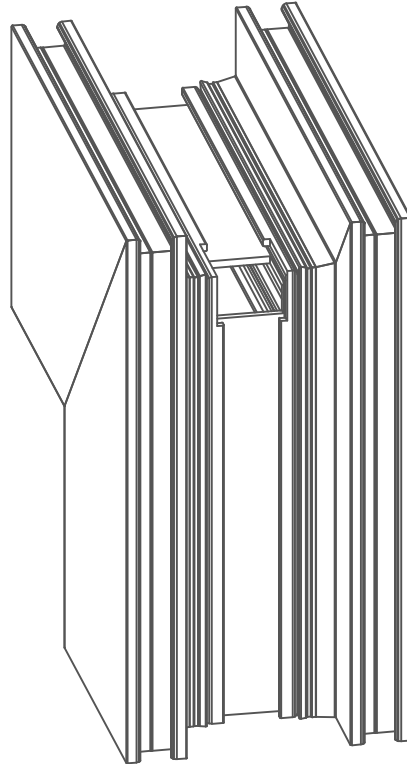
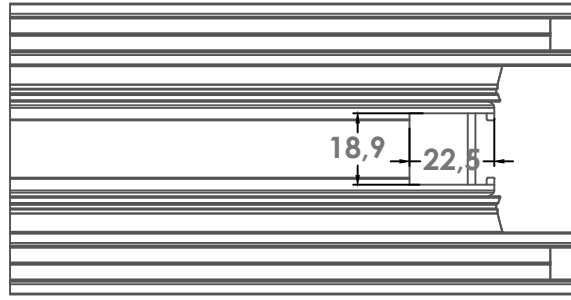
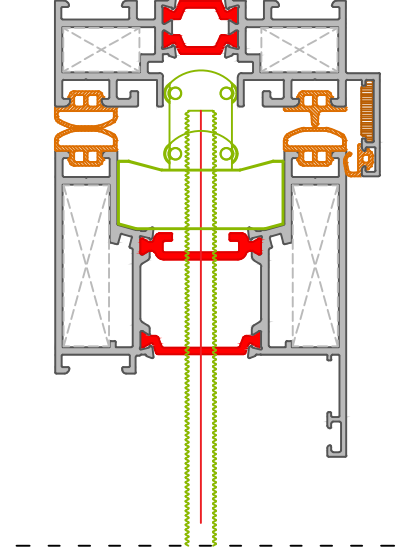
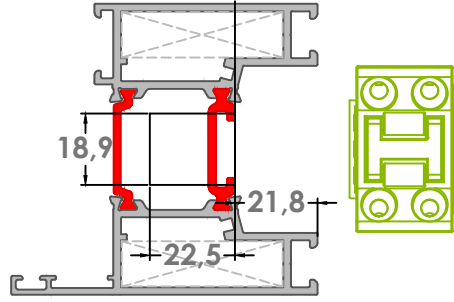
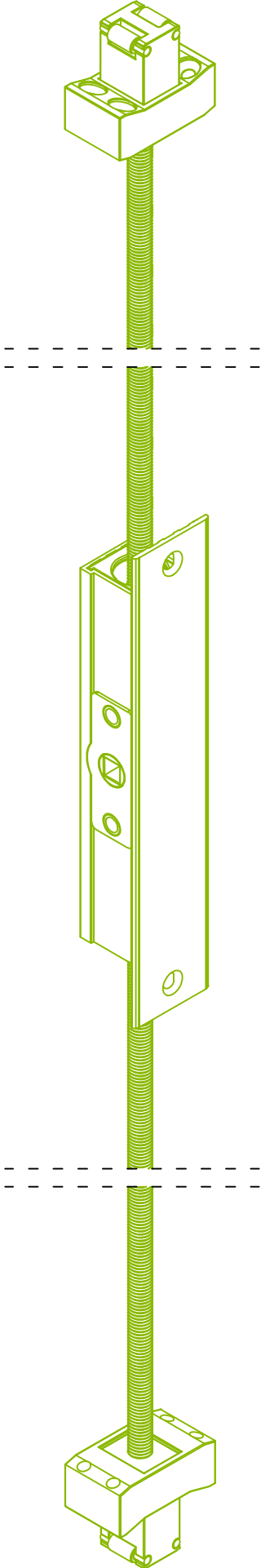

KİLİTLEME SETİ MONTAJ SLOTLARI (LOCKING SET ASSEMBLY)

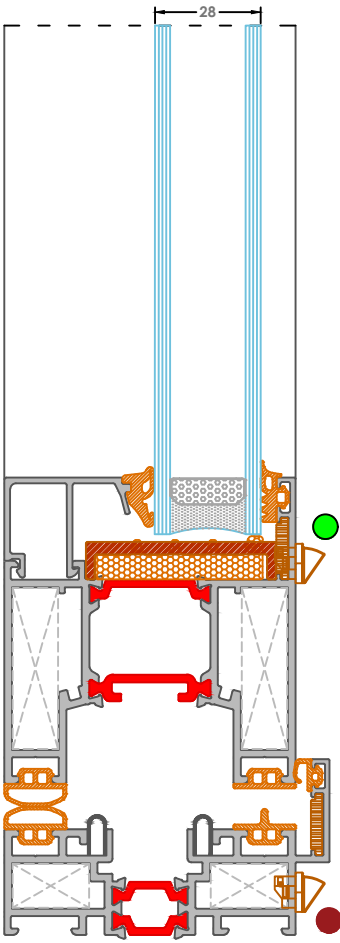

● :SU TAHLİYE KANALI
DRAINAGE

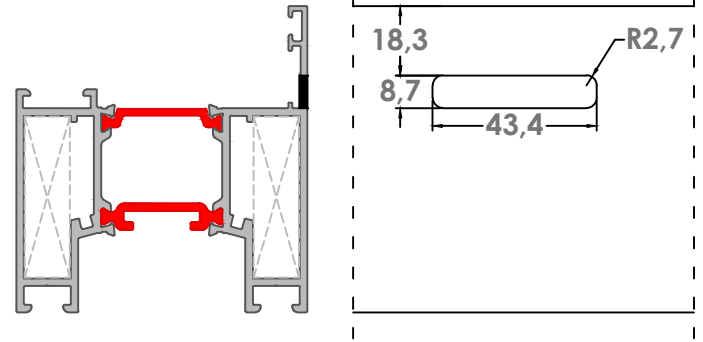

● :SU TAHLİYE KANALI
DRAINAGE

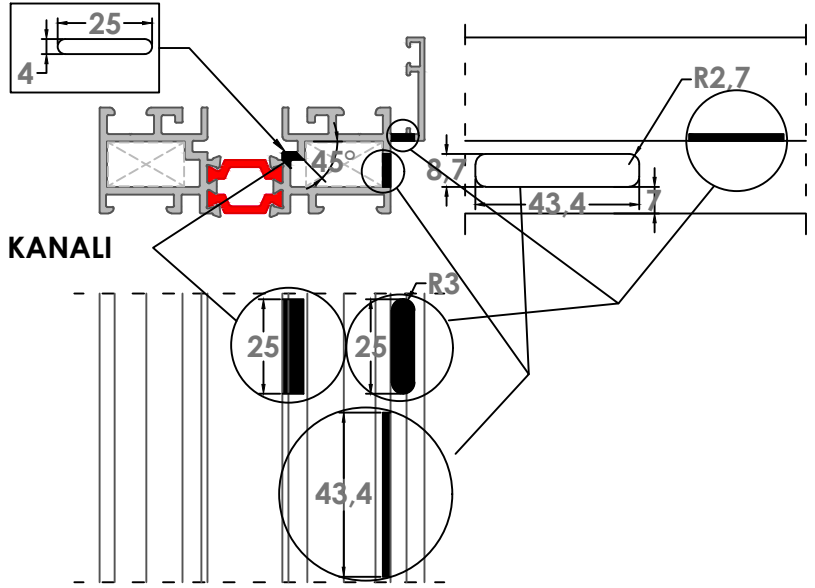

CAM MONTAJI

(GLAZING INSTALLATION)

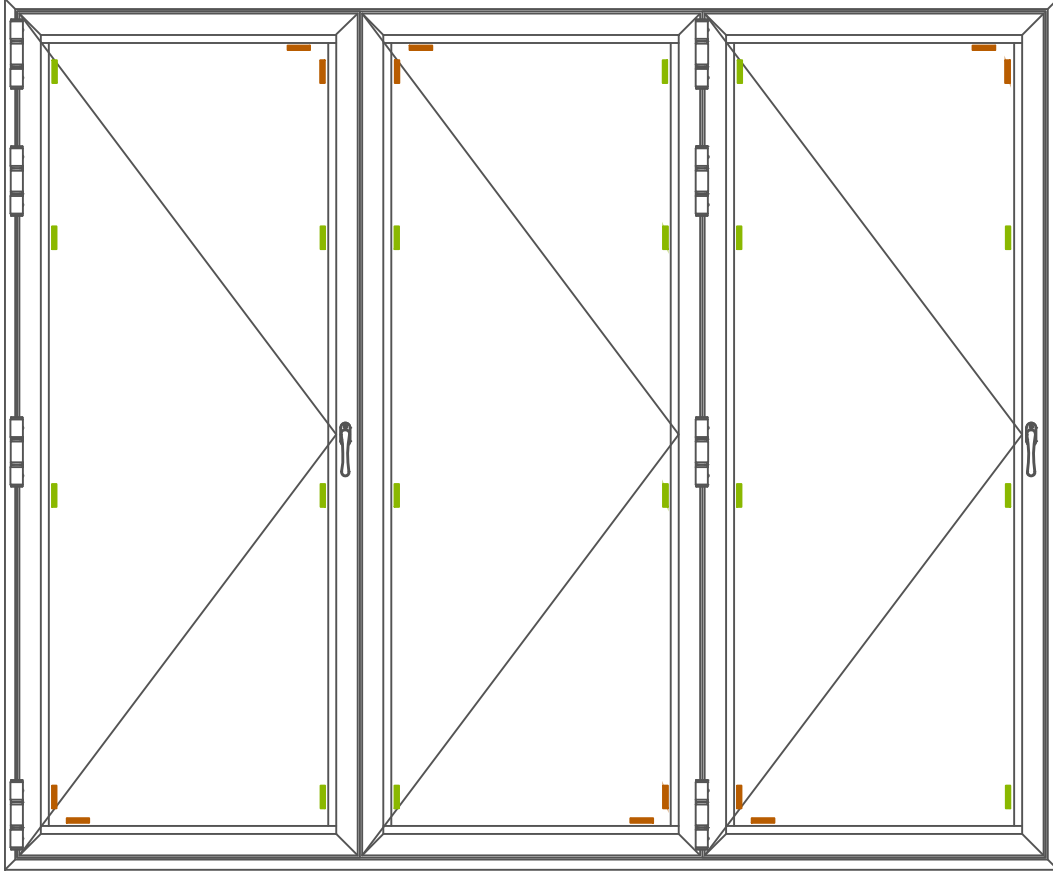

 :CAM TAKOZU
GLASS SUPPORT

 :DESTEK NOKTALARI
SUPPORT POINT

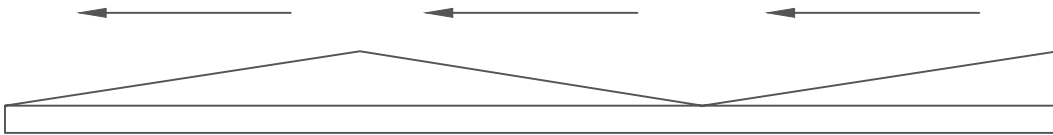

Not: Destek noktalarında cam ve kanat profilinin beraber çalışmasını sağlayacak, Hibrit Mastik (Shore A 40) kullanılması önerilmektedir.

NOTE: It is recommended to use Hybrid Mastik (Shore A 40) at support points to ensure the cooperative functioning of the glass and vent profiles.